

PROPORTIONAL CONTROLS



Section / Description	page
<b>PROPORTIONAL PRESSURE CONTROLS</b>	
PROPORTIONAL PRESSURE REDUCING / RELIEVING VALVES .....	PT3
PROPORTIONAL PRESSURE RELIEF VALVES .....	PT19
<b>PROPORTIONAL FLOW CONTROLS</b>	
2 WAY NORMALLY CLOSED PROPORTIONAL FLOW REGULATOR VALVES .....	PT25
2 WAY NORMALLY OPEN PROPORTIONAL FLOW REGULATOR VALVES .....	PT37
2 WAY NORMALLY CLOSED PRESSURE COMPENSATED PROPORTIONAL FLOW REGULATOR VALVES .....	PT41
3 WAY NORMALLY CLOSED PRESSURE COMPENSATED PROPORTIONAL FLOW REGULATOR VALVES .....	PT47
4W 3P PROPORTIONAL DIRECTIONAL CONTROL VALVES .....	PT53

W 5 / 2018

**WARNING:** the specifications/application data shown in our catalogs and data sheets are intended only as a general guide for the product described (herein). Any specific application should not be undertaken without independent study, evaluation, and testing for suitability.



4484 Boeing Drive Rockford, IL 61109 • USA • Phone +1 (815) 397-6628 • Fax +1 (815) 397-2526  
mail: delta@delta-power.com • www.delta-power.com



Via Malavolti, 36 • 41122 Modena • ITALY • Phone +39 (059) 254895 • Fax +39 (059) 253512  
mail: tecnord@tecnord.com • www.tecnord.com

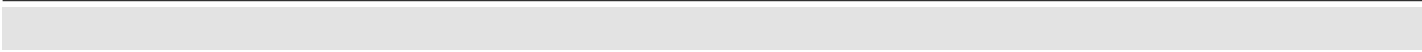

**WARNING:** *the specifications/application data shown in our catalogs and data sheets are intended only as a general guide for the product described (herein). Any specific application should not be undertaken without independent study, evaluation, and testing for suitability.*



4484 Boeing Drive Rockford, IL 61109 • USA • Phone +1 (815) 397-6628 • Fax +1 (815) 397-2526  
mail: [delta@delta-power.com](mailto:delta@delta-power.com) • [www.delta-power.com](http://www.delta-power.com)



Via Malavolti, 36 • 41122 Modena • ITALY • Phone +39 (059) 254895 • Fax +39 (059) 253512  
mail: [tecnord@tecnord.com](mailto:tecnord@tecnord.com) • [www.tecnord.com](http://www.tecnord.com)

**PROPORTIONAL PRESSURE REDUCING / RELIEVING VALVES**

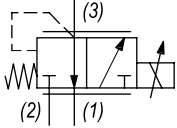
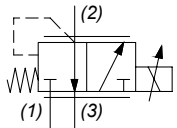
DIRECT ACTING	GPM	PSI	LPM	BAR	CAVITY	MODEL	PAGE
	1	700	4	50	slip-in	<b>IP-DAR-250-L</b>	PT4
	1	700	4	50	slip-in	<b>IP-DAR-43C-L</b>	PT6
	1	5000	4	345	slip-in	<b>IP-DAR-43C-H</b>	PT6
	7.5	700	30	50	slip-in	<b>IP-RDS-222-L</b>	PT8

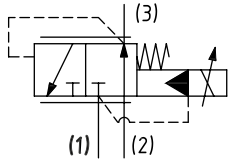
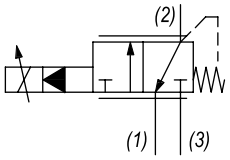
PILOT OPERATED	GPM	PSI	LPM	BAR	CAVITY	MODEL	PAGE
	15	3000	57	207	7/8-14	<b>EF-PRP</b>	PD10
	7.9	700	30	50	slip-in	<b>IP-PRZ-59-AM12</b>	PT12
	7.9	700	30	50	7/8-14	<b>EG-TRZ-42-L</b>	PT14
	7.9	3500	30	241	7/8-14	<b>EG-TRZ-42-H</b>	PT16

W 5 / 2018

**WARNING:** the specifications/application data shown in our catalogs and data sheets are intended only as a general guide for the product described (herein). Any specific application should not be undertaken without independent study, evaluation, and testing for suitability.



4484 Boeing Drive Rockford, IL 61109 • USA • Phone +1 (815) 397-6628 • Fax +1 (815) 397-2526  
 mail: delta@delta-power.com • www.delta-power.com



Via Malavolti, 36 • 41122 Modena • ITALY • Phone +39 (059) 254895 • Fax +39 (059) 253512  
 mail: tecnord@tecnord.com • www.tecnord.com

**IP-DAR-250** DIRECT ACTING PROPORTIONAL, PRESSURE REDUCING/RELIEVING, SLIP-IN TYPE

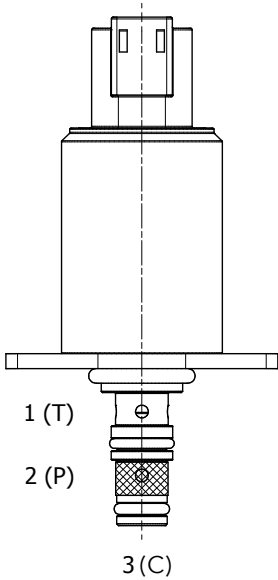

**DESCRIPTION**

Special cavity, slip-in style flange retained, direct acting proportional, pressure reducing/relieving valve.

**OPERATION**

The IP-DAR-250 generates a variable pressure in response to a PWM (Pulse Width Modulated) current signal. With no current applied to the proportional solenoid, the inlet port 2 (P) is blocked and the regulated port 3 (C) is vented to port 1 (T). As current is increased, fluid pressure is proportionally controlled at the regulated port 3 (C). On attainment of proportionally determined pressure at 3 (C), the cartridge shifts to block flow at 2 (P), thereby regulating pressure at 3 (C). In this mode, the valve also will relieve 3 (C) to 1 (T) at a variable value over the set reducing pressure.

**FEATURES**

- Slip-in style.
- Efficient wet-armature construction.
- Integral waterproof coil.
- Continuous duty rated solenoid.



*Flanged retained product. The coil is an integral part of the valve and is not serviceable. Eventual tank pressure exceeding 0 bar, has to be added to reduced pressure value.*

**HYDRAULIC SYMBOL**

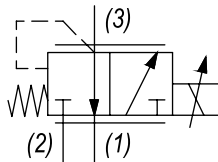

**PERFORMANCE**

**Pressure Vs. Current Characteristic**

*Oil viscosit 46 cSt @ 45°C*

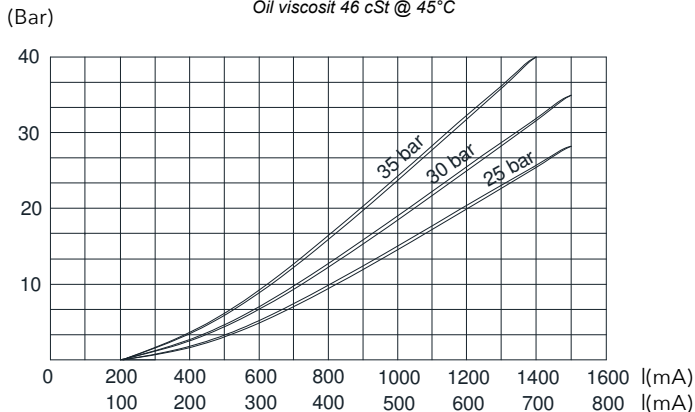

**VALVE SPECIFICATIONS**

Nominal Flow	1 GPM (4 LPM) @ 8 bar Delta P
Max Inlet Pressure "L" version	700 PSI (50 bar)
Controlled Pressure Range	0÷25 bar / 0÷30 bar / 0÷35 bar (see graph)
Reduced Pressure Tolerance	±5%
Max Back-Pressure at T Port	30 bar
Internal Leakage	15 ml/min @ 500 PSI (35 bar) inlet
Viscosity Range	36 to 3000 SSU (3 to 647 cSt)
Filtration	ISO 18/15/13
Media Operating Temp. Range	-30°C / +100°C
Weight	.43 lbs (.20 kg)
Operating Fluid Media	General Purpose Hydraulic Fluid
Cavity	T250
Cavity Tool Kit	K-T250
Flange Mounting Screws and Torque	M4x10 / 3ft-lbs (4 Nm)

**COIL SPECIFICATIONS**

Current Supply Characteristics	PWM (Pulse Width Modulation)
Rated Current Range	200÷1500 (12 V coil) 100÷750 (24 V coil)
PWM or Super-Imposed Dither Freq.	100-200 Hz
Coil Resistance (12 VDC)	4.8 Ohm ±5% at 68°F (20°C)
(24 VDC)	20 Ohm ±5% at 68°F (20°C)
Max Power Consumption	11 Watt (20°C)
Coil Termination	Deutsch-Integral DT04-2P (DT) AMP Jr. Timer 84-9419 (AJ)
Color Connectors	Black
Protection Degree (according to IEC 529)	IP 69K (DT) IP 67 (AJ)

**WARNING:** the specifications/application data shown in our catalogs and data sheets are intended only as a general guide for the product described (herein). Any specific application should not be undertaken without independent study, evaluation, and testing for suitability.



4484 Boeing Drive Rockford, IL 61109 • USA • Phone +1 (815) 397-6628 • Fax +1 (815) 397-2526  
mail: delta@delta-power.com • www.delta-power.com



Via Malavolti, 36 • 41122 Modena • ITALY • Phone +39 (059) 254895 • Fax +39 (059) 253512  
mail: tecnord@tecnord.com • www.tecnord.com

**DIMENSIONS**

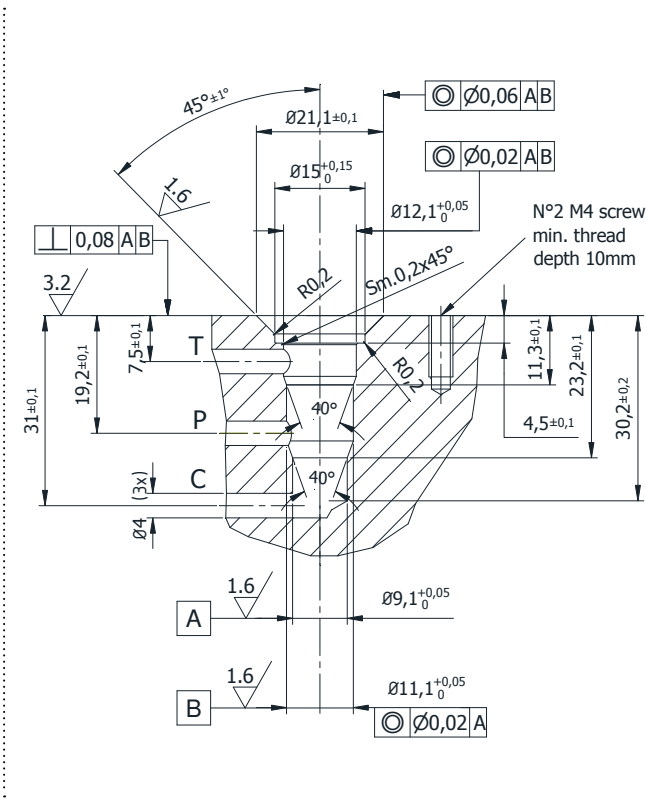
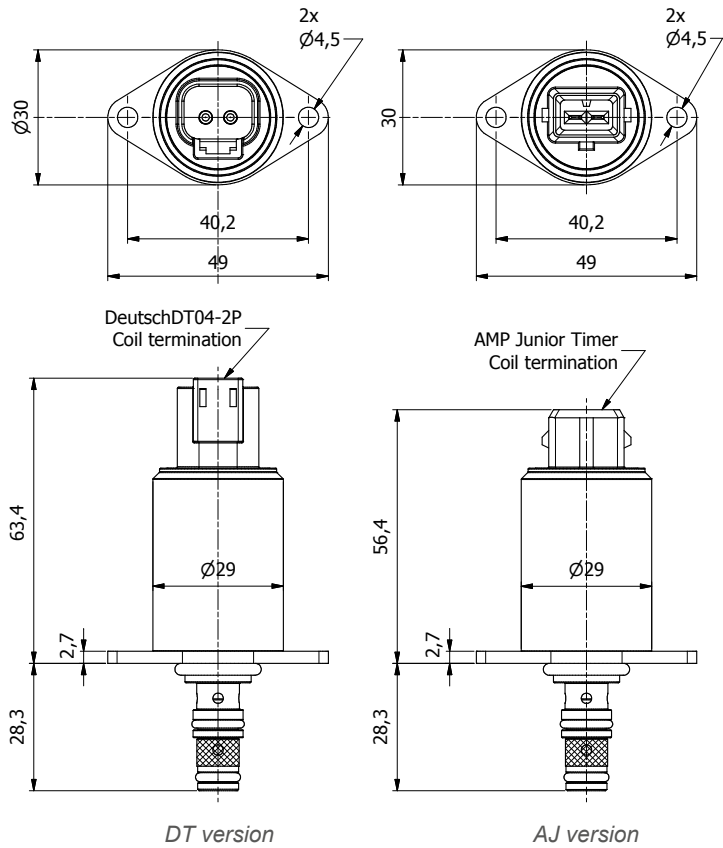

**ORDERING INFORMATION**

IP-DAR-250	COIL TERMINATION	VOLTAGE	INLET PRESSURE	MAX REGULATED PRESSURE	OPTIONS	BODIES
-	AJ - AMP Jr. Timer	12 VDC	L - up to 700 PSI (50 bar)	20 bar	A0 - NBR seals and 300 µm (50 mesh) screen on port 2	Blank - Without body
-	DT - Deutsch DT04	24 VDC		25 bar		N - 1/4" BSP Ports
-				32 bar		

W 5 / 2018

**WARNING:** the specifications/application data shown in our catalogs and data sheets are intended only as a general guide for the product described (herein). Any specific application should not be undertaken without independent study, evaluation, and testing for suitability.



4484 Boeing Drive Rockford, IL 61109 • USA • Phone +1 (815) 397-6628 • Fax +1 (815) 397-2526  
 mail: delta@delta-power.com • www.delta-power.com



Via Malavolti, 36 • 41122 Modena • ITALY • Phone +39 (059) 254895 • Fax +39 (059) 253512  
 mail: tecnord@tecnord.com • www.tecnord.com

**IP-DAR-43C** DIRECT ACTING PROPORTIONAL, PRESSURE REDUCING/RELIEVING, SLIP-IN TYPE

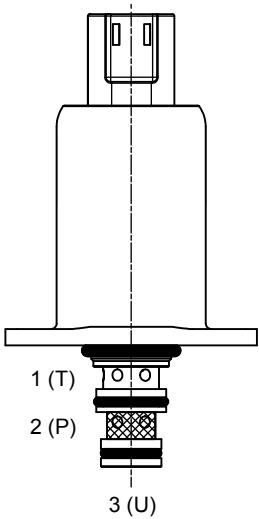

**DESCRIPTION**

Special cavity, slip-in style flange retained, direct acting proportional, pressure reducing/relieving valve.

**OPERATION**

The IP-DAR-43C-AJ12 generates a variable pressure in response to a PWM (Pulse Width Modulated) current signal. With no current applied to the proportional solenoid, the inlet port 2 (P) is blocked and the regulated port 3 (U) is vented to port 1 (T). As current is increased, fluid pressure is proportionally controlled at the regulated port 3 (U). On attainment of proportionally determined pressure at 3 (U), the cartridge shifts to block flow at 2 (P), thereby regulating pressure at 3 (U). In this mode, the valve also will relieve 3 (U) to 1 (T) at a variable value over the set reducing pressure.

**FEATURES**

- Slip-in style.
- Efficient wet-armature construction.
- Integral waterproof coil.
- Continuous duty rated solenoid.



*Flanged retained product. The coil is an integral part of the valve and is not serviceable. Eventual tank pressure exceeding 0 bar, has to be added to reduced pressure value.*

**HYDRAULIC SYMBOL**

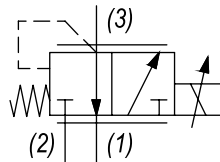

**PERFORMANCE**

**Reduced pressure (bar) vs. Current (mA)**

12 V and 24 V Coil

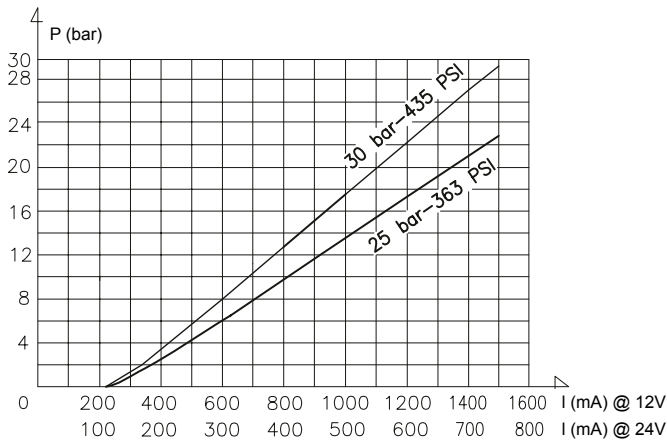

**VALVE SPECIFICATIONS**

Nominal Flow	1 GPM (4 LPM) @ 8 bar Delta P
Max Inlet Pressure "H" version	5000 PSI (345 bar)
Max Inlet Pressure "L" version	700 PSI (50 bar)
Controlled Pressure Range	0÷25 bar / 0÷30 bar (see graph)
Reduced Pressure Tolerance	±5%
Max Back-Pressure at T Port	20 bar
Internal Leakage	15 ml/min @ 500 PSI (35 bar) inlet 35 ml/min @ 5000 PSI (350 bar) inlet
Viscosity Range	36 to 3000 SSU (3 to 647 cSt)
Filtration	ISO 18/15/13
Media Operating Temp. Range	-30°C / +100°C
Weight	.54 lbs (.25 kg)
Operating Fluid Media	General Purpose Hydraulic Fluid
Cavity	T043
Cavity Tool Kit	K-T043
Flange Mounting Screws and Torque	M4x10 / 3ft-lbs (4 Nm)

**COIL SPECIFICATIONS**

Current Supply Characteristics	PWM (Pulse Width Modulation)
Rated Current Range	200÷1500 (12 V coil) 100÷750 (24 V coil)
PWM or Super-Imposed Dither Freq.	100-200 Hz
Coil Resistance (12 VDC)	5.4 Ohm ±5% at 68°F (20°C)
Coil Resistance (24 VDC)	22 Ohm ±5% at 68°F (20°C)
Max Power Consumption	12 Watt (20°C)
Protection Degree	IP 67 according to IEC 529
Coil Termination	Deutsch-Integral DT04-2P AMP Jr. Timer 84-9419
Color Connectors	Black

**WARNING:** the specifications/application data shown in our catalogs and data sheets are intended only as a general guide for the product described (herein). Any specific application should not be undertaken without independent study, evaluation, and testing for suitability.



4484 Boeing Drive Rockford, IL 61109 • USA • Phone +1 (815) 397-6628 • Fax +1 (815) 397-2526  
mail: delta@delta-power.com • www.delta-power.com



Via Malavolti, 36 • 41122 Modena • ITALY • Phone +39 (059) 254895 • Fax +39 (059) 253512  
mail: tecnord@tecnord.com • www.tecnord.com

**DIMENSIONS**

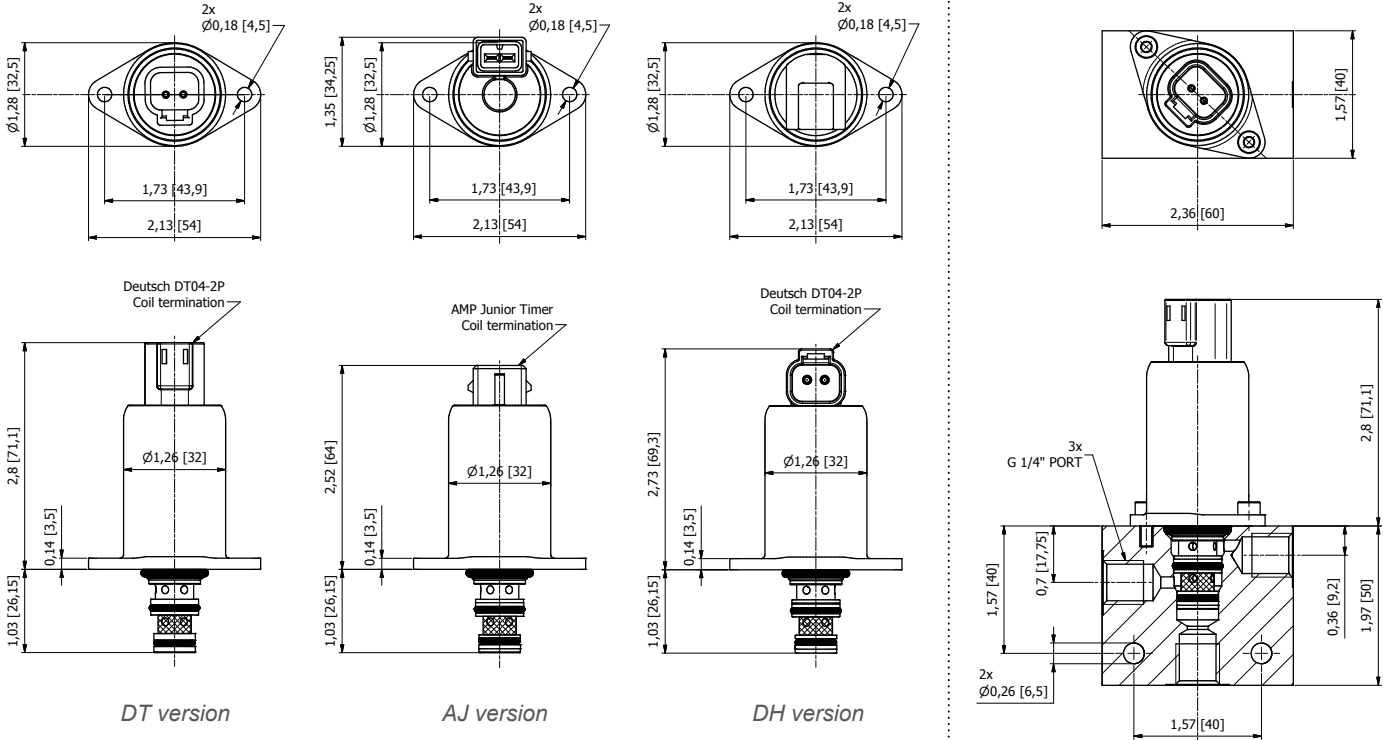

**ORDERING INFORMATION**

**IP-DAR-43C**

<u>COIL TERMINATION</u>	<u>VOLTAGE</u>	<u>INLET PRESSURE</u>	<u>MAX REGULATED PRESSURE</u>	<u>OPTIONS</u>	<u>BODIES</u>
AJ - AMP Jr. Timer	12 VDC	L - up to 700 PSI (50 bar)	25 bar	A0 - NBR seals and 300 $\mu$ m (50 mesh) screen on port 2	Blank - Without body
DT - Deutsch DT04	24 VDC	H - up to 5000 PSI (350 bar)	30 bar		N - 1/4" BSP Ports
DH - Deutsch DT04 Horizontal					S - #6 SAE Ports

W 5 / 2018

**WARNING:** the specifications/application data shown in our catalogs and data sheets are intended only as a general guide for the product described (herein). Any specific application should not be undertaken without independent study, evaluation, and testing for suitability.



4484 Boeing Drive Rockford, IL 61109 • USA • Phone +1 (815) 397-6628 • Fax +1 (815) 397-2526  
 mail: delta@delta-power.com • www.delta-power.com



Via Malavolti, 36 • 41122 Modena • ITALY • Phone +39 (059) 254895 • Fax +39 (059) 253512  
 mail: tecnord@tecnord.com • www.tecnord.com

**IP-RDS-222 DIRECT ACTING PROPORTIONAL, PRESSURE REDUCING/RELIEVING, SLIP-IN TYPE**

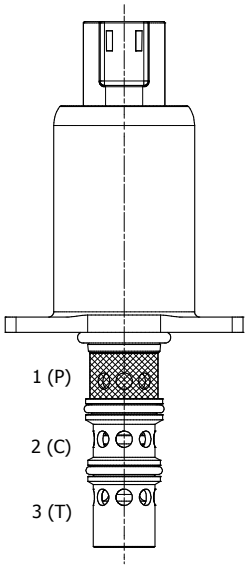

**DESCRIPTION**

Special cavity, slip-in style flange retained, "step bore" direct acting proportional, pressure reducing/relieving valve.

**OPERATION**

The IP-RDS-222 generates a variable pressure in response to a PWM (Pulse Width Modulated) current signal. With no current applied to the proportional solenoid, the inlet port 1 (P) is blocked and the regulated port 2 (C) is vented to port 3 (T). As current is increased, fluid pressure is proportionally controlled at the regulated port 2 (C). On attainment of proportionally determined pressure at 2 (C), the cartridge shifts to block flow at 1 (P), thereby regulating pressure at 2 (C). In this mode, the valve also will relieve 2 (C) to 3 (T) at a variable value over the set reducing pressure.

**FEATURES**

- Slip-in style.
- Efficient wet-armature construction.
- Integral waterproof coil.
- Continuous duty rated solenoid.



*Flanged retained product. The coil is an integral part of the valve and is not serviceable. Eventual tank pressure exceeding 0 bar, has to be added to reduced pressure value.*

**HYDRAULIC SYMBOL**

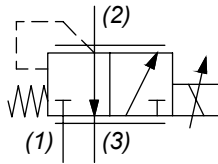

**PERFORMANCE**

**Pressure Vs. Current Characteristic**

Oil viscosit 46 cSt @ 45°C and PWM 100 Hz

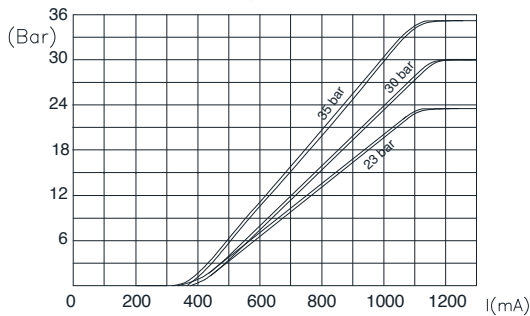

**Pressure Drop**

Oil viscosit 46 cSt @ 45°C

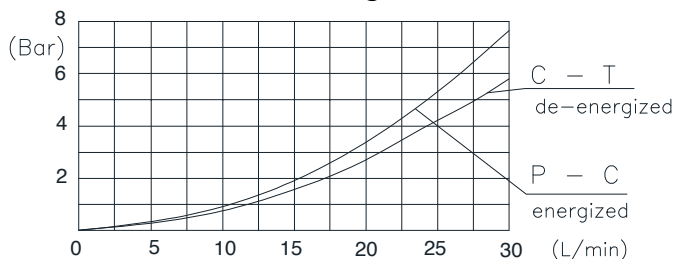

**VALVE SPECIFICATIONS**

Nominal Flow	7.5 GPM (30 LPM) @ 6 bar Delta P
Max Inlet Pressure "L" version	700 PSI (50 bar)
Controlled Pressure Range	0÷23 bar / 0÷30 bar / 0÷35 bar (see graph)
Reduced Pressure Tolerance	±5%
Max Back-Pressure at T Port	25 bar
Internal Leakage	15 ml/min @ 500 PSI (35 bar) inlet
Viscosity Range	36 to 3000 SSU (3 to 647 cSt)
Filtration	ISO 18/15/13
Media Operating Temp. Range	-30°C / +100°C
Weight	.58 lbs (.27 kg)
Operating Fluid Media	General Purpose Hydraulic Fluid
Cavity	T222
Cavity Tool Kit	K-T222
Flange Mounting Screws and Torque	M4x10 / 3ft-lbs (4 Nm)

**COIL SPECIFICATIONS**

Current Supply Characteristics	PWM (Pulse Width Modulation)
Rated Current Range	200÷1500 (12 V coil) 100÷750 (24 V coil)
PWM or Super-Imposed Dither Freq.	100-200 Hz
Coil Resistance (12 VDC)	5.4 Ohm ±5% at 68°F (20°C)
(24 VDC)	22 Ohm ±5% at 68°F (20°C)
Max Power Consumption	12 Watt (20°C)
Coil Termination	Deutsch-Integral DT04-2P (DT & DH) AMP Jr. Timer 84-9419 (AJ)
Color Connectors	Black
Protection Degree (according to IEC 529)	IP 69K (DT & DH) IP 67 (AJ)

**WARNING:** the specifications/application data shown in our catalogs and data sheets are intended only as a general guide for the product described (herein). Any specific application should not be undertaken without independent study, evaluation, and testing for suitability.



4484 Boeing Drive Rockford, IL 61109 • USA • Phone +1 (815) 397-6628 • Fax +1 (815) 397-2526  
mail: delta@delta-power.com • www.delta-power.com



Via Malavolti, 36 • 41122 Modena • ITALY • Phone +39 (059) 254895 • Fax +39 (059) 253512  
mail: tecnord@tecnord.com • www.tecnord.com



DIMENSIONS

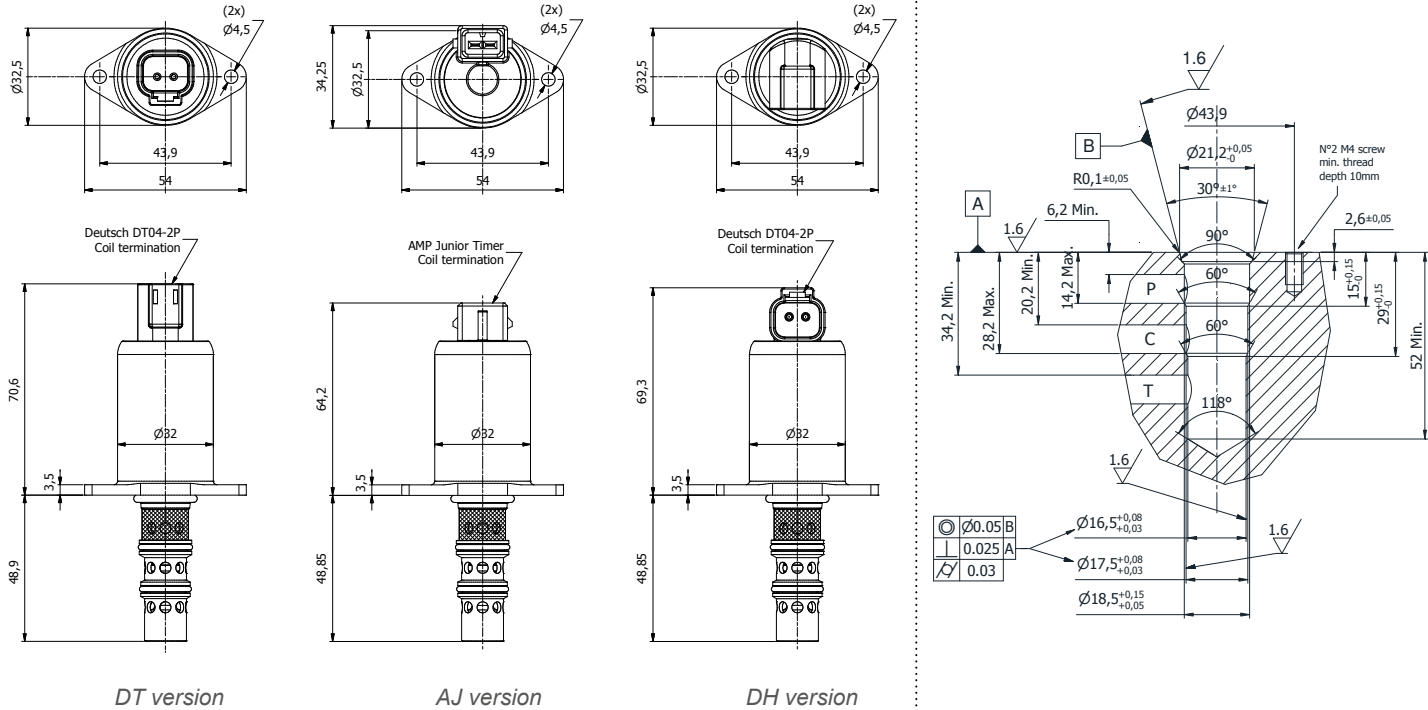

ORDERING INFORMATION

IP-RDS-222	COIL TERMINATION	VOLTAGE	INLET PRESSURE	MAX REGULATED PRESSURE	OPTIONS	BODIES
	AJ - AMP Jr. Timer	12 VDC	L - up to 700 PSI (50 bar)	23 bar	A0 - NBR seals and 300 µm (50 mesh) screen on port 2	Blank - Without body
	DT - Deutsch DT04	24 VDC		30 bar		N - 3/8" BSP Ports
	DH - Deutsch DT04 Horizontal			35 bar		

W 5 / 2018

WARNING: the specifications/application data shown in our catalogs and data sheets are intended only as a general guide for the product described (herein). Any specific application should not be undertaken without independent study, evaluation, and testing for suitability.



4484 Boeing Drive Rockford, IL 61109 • USA • Phone +1 (815) 397-6628 • Fax +1 (815) 397-2526  
 mail: delta@delta-power.com • www.delta-power.com



Via Malavolti, 36 • 41122 Modena • ITALY • Phone +39 (059) 254895 • Fax +39 (059) 253512  
 mail: tecnord@tecnord.com • www.tecnord.com

**EF-PRP 3 WAY 2 POSITION, PILOT OPERATED, PRESSURE REDUCING, RELIEVING VALVE**

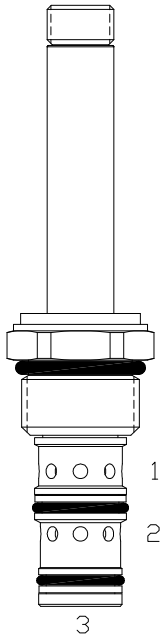

**DESCRIPTION**

10 size, 7/8-14 thread, "Delta" series, pilot operated, 3 way 2 position, proportional pressure reducing/relieving valve.

**OPERATION**

When de-energized and with a passive load at port (3), the EF-PRP passes sufficient flow from port (2) to port (3) to regulate a minimum pressure of approximately 3-10 Bar (45-145 PSI). With a supplied flow from an external source into port (3) the valve will regulate the minimum pressure as shown on curve below by bypassing flow to port (1). When energized, the actuator creates a force proportional to the applied current to then determine the pressure that will be regulated at port (3). Oil is supplied from port (2) to port (3) until desired pressure is reached. If pressure at port (3) exceeds desired level, excess oil is vented to port (1) until desired level is reached. Pressures at port (1) are additive to regulated pressure at port (3).

**FEATURES**

- Efficient wet-armature construction.
- Cartridges are voltage interchangeable.
- Industry common cavity.
- Unitized, molded coil design.
- Continuous duty rated solenoid.
- Optional coil voltages and terminations.
- Optional "I" Coil: Weatherproof, Thermal Shock, Immersion Safe

**HYDRAULIC SYMBOL**

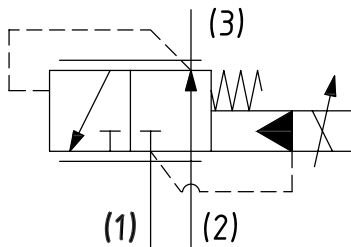

**PERFORMANCE**

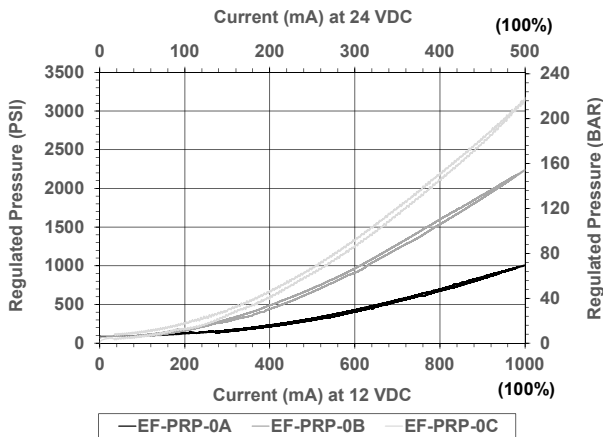

**VALVE SPECIFICATIONS**

Nominal Flow	15 GPM (57 LPM)
Rated Operating Pressure	3000 PSI (207 bar)
Viscosity Range	36 to 3000 SSU (3 to 647 cSt)
Filtration	ISO 18/16/13
Media Operating Temp. Range	-40°C to 250°F (-40°C to 120°C)
Weight	.59 lbs (.27 kg)
Operating Fluid Media	General Purpose Hydraulic Fluid
Cartridge Torque Requirements	30 ft-lbs (40.6 Nm)
Cavity	DELTA 3W
Cavity Form Tool (Finishing)	40500001
Seal Kit	21191206

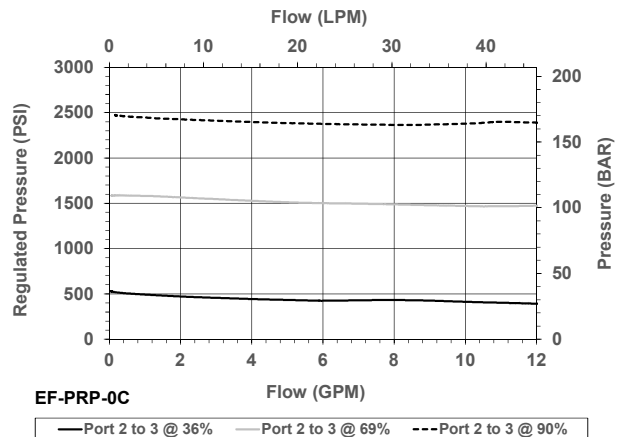

**WARNING:** the specifications/application data shown in our catalogs and data sheets are intended only as a general guide for the product described (herein). Any specific application should not be undertaken without independent study, evaluation, and testing for suitability.



4484 Boeing Drive Rockford, IL 61109 • USA • Phone +1 (815) 397-6628 • Fax +1 (815) 397-2526  
 mail: delta@delta-power.com • www.delta-power.com



Via Malavolti, 36 • 41122 Modena • ITALY • Phone +39 (059) 254895 • Fax +39 (059) 253152  
 mail: tecnord@tecnord.com • www.tecnord.com

**DIMENSIONS**

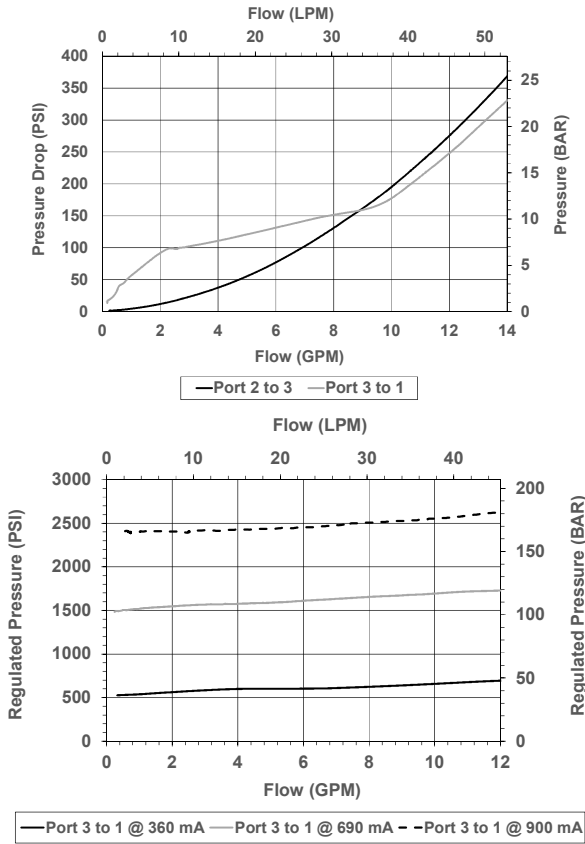

**ORDERING INFORMATION**

Approximate Coil Weight: .30 lbs (.14 kg)

EF-PRP - - - -

**OPTIONS**

- Buna, 150-1015 PSI range **0A**
- Viton, 150-1015 PSI range **VA**
- Buna, 150-2175 PSI range **0B**
- Viton, 150-2175 PSI range **VB**
- Buna, 150-3000 PSI range **0C**
- Viton, 150-3000 PSI range **VC**

**BODIES**

- Blank** Without Body
- N** 1/4" NPTF Ports
- S** #6 SAE Ports

**VOLTAGE**

- 06** 6 VDC
- 12** 12 VDC
- 24** 24 VDC
- 36** 36 VDC
- 48** 48 VDC
- 25** 24 VAC
- 11** 120 VAC
- 22** 220 VAC
- 44** 440 VAC

**"P" COIL TERMINATION**

- DL** Double Lead
- DT** Deutsch on Leads DT04-2P
- ML** Metri-Pack on Leads
- PL** Packard on Leads
- WL** Weatherpack on Leads
- SS** Single Spade
- DS** Double Spade
- HC** DIN 43650 (Hirschmann) - (AC & DC)
- CL** Conduit Lead - (AC Only)
- DI** Deutsch - Integral DT04-2P

**WARNING:** the specifications/application data shown in our catalogs and data sheets are intended only as a general guide for the product described (herein). Any specific application should not be undertaken without independent study, evaluation, and testing for suitability.

W 5 / 2018



4484 Boeing Drive Rockford, IL 61109 • USA • Phone +1 (815) 397-6628 • Fax +1 (815) 397-2526  
 mail: delta@delta-power.com • www.delta-power.com



Via Malavolti, 36 • 41122 Modena • ITALY • Phone +39 (059) 254895 • Fax +39 (059) 253512  
 mail: tecnord@tecnord.com • www.tecnord.com

**IP-PRZ-59-AM12** PILOT OPERATED PROPORTIONAL, PRESSURE REDUCING/RELIEVING, SLIP-IN TYPE

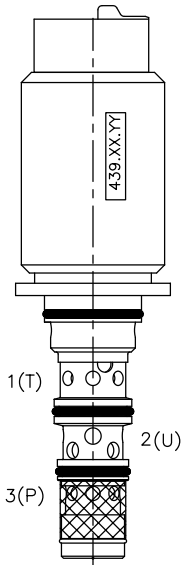

**DESCRIPTION**

Special cavity, flange retained, slip-in proportional pressure reducing/relieving valve.

**OPERATION**

The IP-PRZ-59-AM12 generates a variable pressure in response to a PWM (Pulse Width Modulated) current signal. With no current applied to the proportional solenoid, the inlet port 3 (P) is blocked and the regulated port 2 (U) is vented to port 1 (T). As current is increased, fluid pressure is proportionally controlled at the regulated port 3 (P). On attainment of proportionally determined pressure at 2 (U), the cartridge shifts to block flow at 3 (P), thereby regulating pressure at 2 (U). In this mode, the valve also will relieve 2 (U) to 1 (T) at a variable value over the set reducing pressure.

**FEATURES**

- Economical slip-in style.
- Integral waterproof coil.
- Efficient wet-armature construction.
- Hardened parts for long life.



*Flanged Retained Product. The coil (12 VDC) is an integral part of the valve and is not serviceable. Inlet pressure up to 50 bar. Max regulated pressure can be increased up to 35 bar (factory preset).*

**HYDRAULIC SYMBOL**

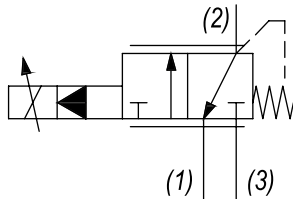

**PERFORMANCE**

**Reduced pressure (bar) vs. Current (mA)**

12 V coil, 24 bar inlet pressure

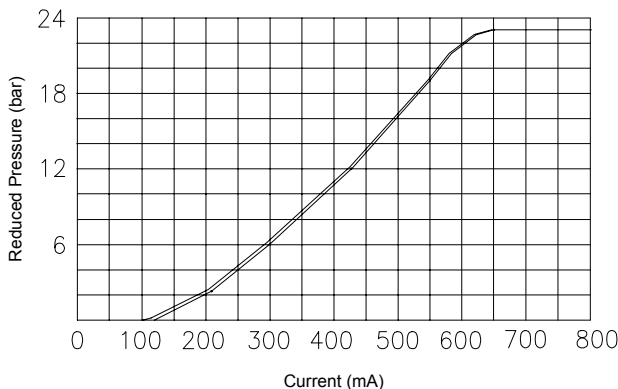

Curve is attained with SAE 40 - Grade oil @ 50°C

**VALVE SPECIFICATIONS**

Nominal Flow	7.9 GPM (30 LPM) @ 3 bar DeltaP
Max Inlet Pressure	700 PSI (50 bar)
Controlled Pressure Range	(see graph)
Max Internal Leakage	<500 cc/min @ 35 bar
Viscosity Range	5 to 5000 cSt
Filtration	ISO 18/15/13
Media Operating Temp. Range	-30°C / +100°C
Weight	.63 lbs (.29 kg)
Operating Fluid Media	General Purpose Hydraulic Fluid
Cavity	T059
Cavity Tools Kit (form tool, reamer, tap)	K-T059
Flange Mounting Screws and Torque	M6x10 / 4 ft-lbs (6 Nm)

**COIL SPECIFICATIONS**

Current Supply Characteristics	PWM (Pulse Width Modulation)
Rated Current Range	100-900 mA
PWM or Super-Imposed	
Dither Frequency	100-150 Hz
Coil Resistance (12 VDC)	10 Ohm ±5% at 68°F (20°C)
Max Power Consumption	14 Watt
Protection Degree	IP 67 according to IEC 529
Coil Termination	AMP Superseal 1.5 Series 282080-1 Type
Color Connectors	Green

**WARNING:** the specifications/application data shown in our catalogs and data sheets are intended only as a general guide for the product described (herein). Any specific application should not be undertaken without independent study, evaluation, and testing for suitability.



4484 Boeing Drive Rockford, IL 61109 • USA • Phone +1 (815) 397-6628 • Fax +1 (815) 397-2526  
mail: delta@delta-power.com • www.delta-power.com



Via Malavolti, 36 • 41122 Modena • ITALY • Phone +39 (059) 254895 • Fax +39 (059) 253512  
mail: tecnord@tecnord.com • www.tecnord.com

**DIMENSIONS**

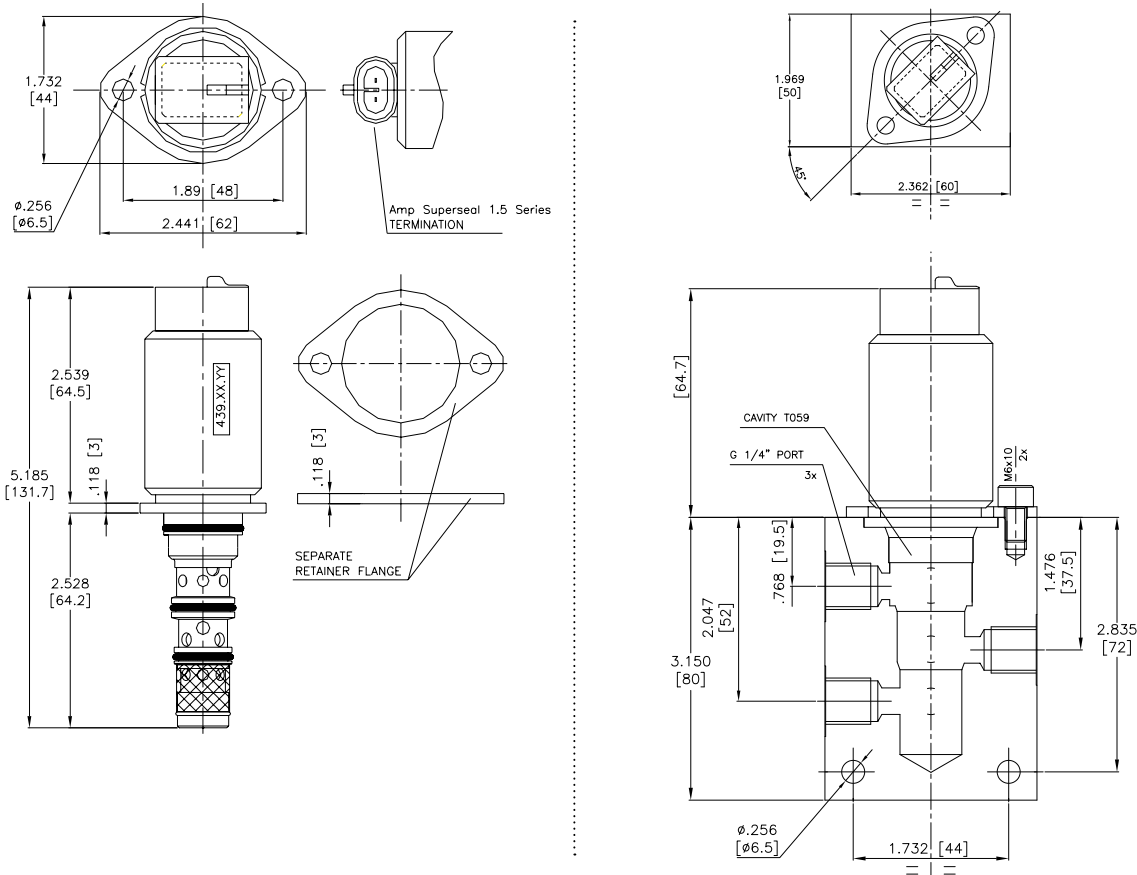

**ORDERING INFORMATION**

IP-PRZ-59-AM12 -

**OPTIONS**

Buna Standard  
Buna, Screen

00  
A0

Blank  
N  
S

**BODIES**

Without Body  
1/4" BSP Ports  
#6 SAE Ports

**NOTE:** screen (on inlet port): mesh 47 (280  $\mu$ m)

W 5 / 2018

**WARNING:** the specifications/application data shown in our catalogs and data sheets are intended only as a general guide for the product described (herein). Any specific application should not be undertaken without independent study, evaluation, and testing for suitability.



4484 Boeing Drive Rockford, IL 61109 • USA • Phone +1 (815) 397-6628 • Fax +1 (815) 397-2526  
mail: delta@delta-power.com • www.delta-power.com



Via Malavolti, 36 • 41122 Modena • ITALY • Phone +39 (059) 254895 • Fax +39 (059) 253512  
mail: tecnord@tecnord.com • www.tecnord.com

**EG-TRZ-42-L PILOT OPERATED PROPORTIONAL, PRESSURE REDUCING/RELIEVING**

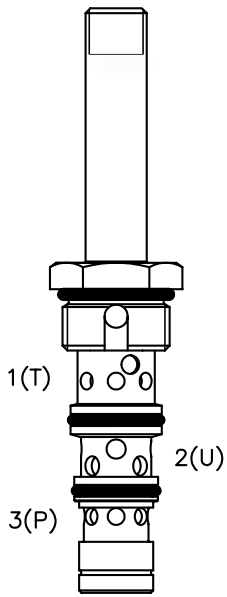

**DESCRIPTION**

Special cavity, 7/8-14 thread, pilot operated proportional pressure reducing/relieving valve.

**OPERATION**

The EG-TRZ-42-L generates a variable pressure in response to a PWM (Pulse Width Modulated) current signal. With no current applied to the proportional solenoid, the inlet port 3 (P) is blocked and the regulated port 2 (U) is vented to port 1 (T).

As current is increased, fluid pressure is proportionally controlled at the regulated port 2 (U). On attainment of proportionally determined pressure at 2 (U), the cartridge shifts to block flow at 3 (P), thereby regulating pressure at 2 (U). In this mode, the valve also will relieve 2 (U) to 1 (T) at a variable value over the set reducing pressure.

**FEATURES**

- Hardened parts for long life.
- Efficient wet-armature construction.
- Unitized valve/coil.
- Continuous duty rated solenoid.

**HYDRAULIC SYMBOL**

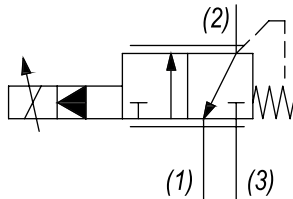

**PERFORMANCE**

**Pressure vs. Current characteristic**

*Inlet pressure 36 bar, Oil viscosity 46 cSt @ 45°C*

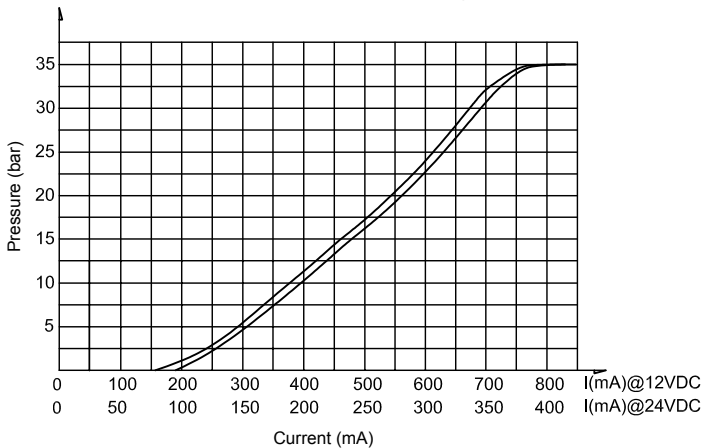

**VALVE SPECIFICATIONS**

Nominal Flow	7.9 GPM (30 LPM)
Max Inlet Pressure	700 PSI (50 bar)
Controlled Pressure Range	(see graph)
Max Internal Leakage	700 cc/min @ 50 bar
Max Back-Pressure at T Port	20 bar
Viscosity Range	36 to 3000 SSU (3 to 647 cSt)
Filtration	ISO 18/15/13
Media Operating Temp. Range	-30°C / +100°C
Weight	.63 lbs (.29 kg)
Operating Fluid Media	General Purpose Hydraulic Fluid
Cartridge Torque Requirements	16 ft-lbs (30 Nm)
Coil Nut Torque Requirements	1-2 ft-lbs (2-3 Nm)
Cavity	T042
Cavity Tools Kit (form tool, reamer, tap)	K-T042

**COIL SPECIFICATIONS**

Current Supply Characteristics	PWM (Pulse Width Modulation)
Rated Current Range	100-1000 mA with 12 VDC Coil 50-500 mA with 24 VDC Coil
PWM or Super-Imposed	
Dither Frequency	150-200 Hz
Coil Resistance	7.8 Ohm ±5% at 68°F (20°C) 12 VDC 32 Ohm ±5% at 68°F (20°C) 24 VDC
Max Power Consumption	18 Watt

**WARNING:** the specifications/application data shown in our catalogs and data sheets are intended only as a general guide for the product described (herein). Any specific application should not be undertaken without independent study, evaluation, and testing for suitability.



4484 Boeing Drive Rockford, IL 61109 • USA • Phone +1 (815) 397-6628 • Fax +1 (815) 397-2526  
mail: delta@delta-power.com • www.delta-power.com



Via Malavolti, 36 • 41122 Modena • ITALY • Phone +39 (059) 254895 • Fax +39 (059) 253512  
mail: tecnord@tecnord.com • www.tecnord.com

**DIMENSIONS**

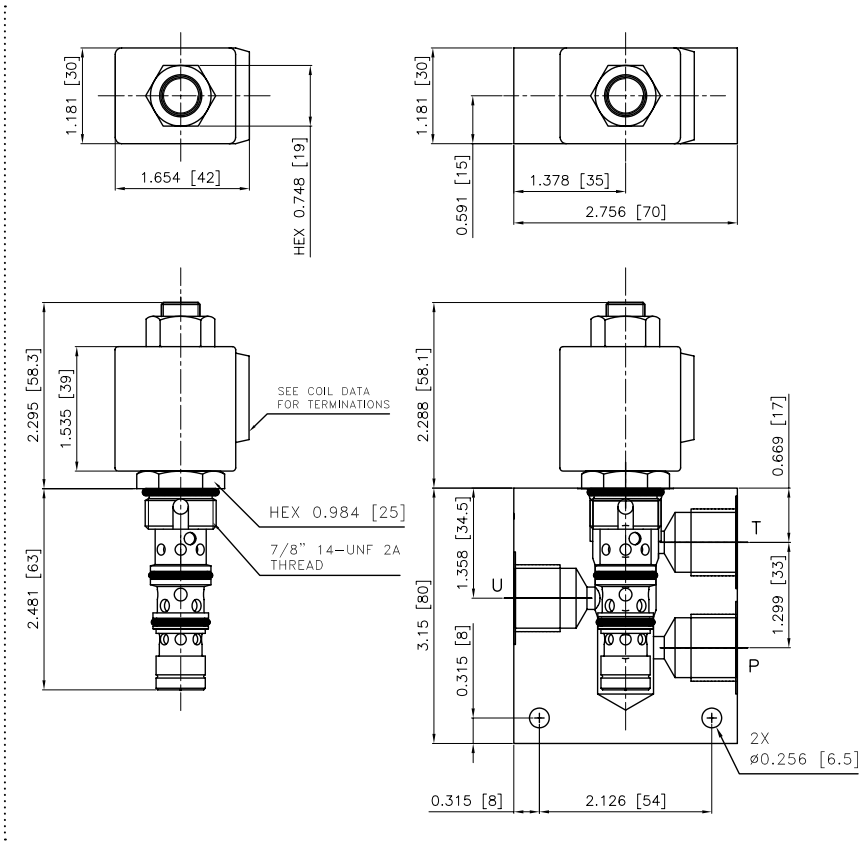
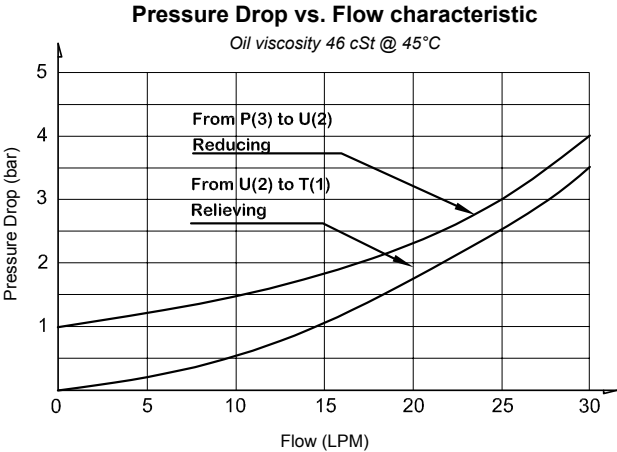

**ORDERING INFORMATION**

Approximate Coil Weight: .42 lbs (.19 kg)

<b>EG-TRZ-42-L</b>	-	-	-	-	-
<b>MAX REGULATED PRESSURE</b>	<b>OPTIONS</b>	<b>"A" COIL TERMINATION</b>	<b>VOLTAGE</b>	<b>BODIES</b>	
35 bar	00 - Buna Standard A0 - Buna Screen	DL - Double Lead HC - DIN 43650 (Hirschmann) JT - AMP Jr. Timer	12 - 12 VDC 24 - 24 VDC	Blank - Without body N - 3/8" BSP Ports	
		DT - Deutsch DT04-2P			

W 5 / 2018

**WARNING:** the specifications/application data shown in our catalogs and data sheets are intended only as a general guide for the product described (herein). Any specific application should not be undertaken without independent study, evaluation, and testing for suitability.



4484 Boeing Drive Rockford, IL 61109 • USA • Phone +1 (815) 397-6628 • Fax +1 (815) 397-2526  
mail: delta@delta-power.com • www.delta-power.com



Via Malavolti, 36 • 41122 Modena • ITALY • Phone +39 (059) 254895 • Fax +39 (059) 253512  
mail: tecnord@tecnord.com • www.tecnord.com

**EG-TRZ-42-H PILOT OPERATED PROPORTIONAL, PRESSURE REDUCING/RELIEVING**

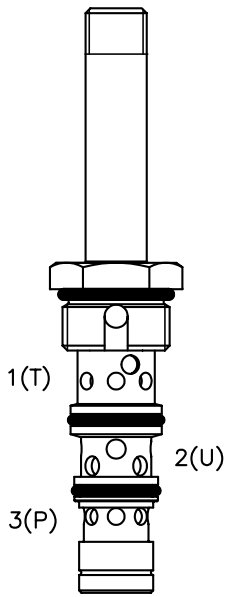

**DESCRIPTION**

Special cavity, 7/8-14 thread, pilot operated proportional pressure reducing/relieving valve.

**OPERATION**

The EG-TRZ-42-H generates a variable pressure in response to a PWM (Pulse Width Modulated) current signal. With no current applied to the proportional solenoid, the inlet port 3 (P) is blocked and the regulated port 2 (U) is vented to port 1 (T).

As current is increased, fluid pressure is proportionally controlled at the regulated port 2 (U). On attainment of proportionally determined pressure at 2 (U), the cartridge shifts to block flow at 3 (P), thereby regulating pressure at 2 (U). In this mode, the valve also will relieve 2 (U) to 1 (T) at a variable value over the set reducing pressure.

**FEATURES**

- Hardened parts for long life.
- Efficient wet-armature construction.
- Unitized valve/coil.
- Continuous duty rated solenoid.

**HYDRAULIC SYMBOL**

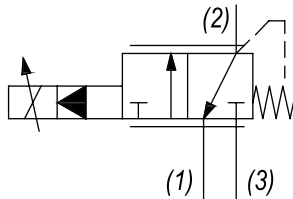

**PERFORMANCE**

**Pressure vs. Current characteristic**

Oil viscosity 46 cSt @ 45°C

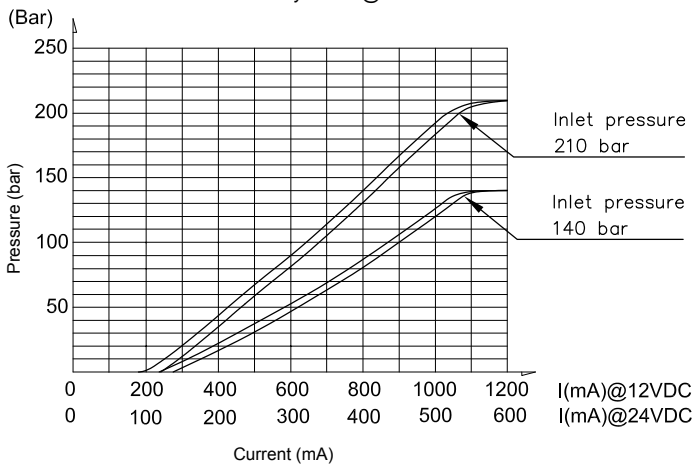

**VALVE SPECIFICATIONS**

Nominal Flow	7.9 GPM (30 LPM)
Max Inlet Pressure	3500 PSI (241 bar)
Controlled Pressure Range	(see graph)
Max Internal Leakage	1500 ml/min @ 200 bar inlet pressure
Max Back-Pressure at T Port	20 bar
Viscosity Range	36 to 3000 SSU (3 to 647 cSt)
Filtration	ISO 18/15/13
Media Operating Temp. Range	-30°C / +100°C
Weight	.63 lbs (.29 kg)
Operating Fluid Media	General Purpose Hydraulic Fluid
Cartridge Torque Requirements	16 ft-lbs (30 Nm)
Coil Nut Torque Requirements	1-2 ft-lbs (2-3 Nm)
Cavity	T042
Cavity Tools Kit (form tool, reamer, tap)	K-T042

**COIL SPECIFICATIONS**

Current Supply Characteristics	PWM (Pulse Width Modulation)
Rated Current Range	100-1200 mA with 12 VDC Coil 50-600 mA with 24 VDC Coil
PWM or Super-Imposed	
Dither Frequency	150-200 Hz
Coil Resistance	6.85 Ohm ±5% at 68°F (20°C) 12 VDC 27 Ohm ±5% at 68°F (20°C) 24 VDC
Max Power Consumption	21 Watt

**WARNING:** the specifications/application data shown in our catalogs and data sheets are intended only as a general guide for the product described (herein). Any specific application should not be undertaken without independent study, evaluation, and testing for suitability.



4484 Boeing Drive Rockford, IL 61109 • USA • Phone +1 (815) 397-6628 • Fax +1 (815) 397-2526  
mail: delta@delta-power.com • www.delta-power.com



Via Malavolti, 36 • 41122 Modena • ITALY • Phone +39 (059) 254895 • Fax +39 (059) 253512  
mail: tecnord@tecnord.com • www.tecnord.com



DIMENSIONS

Pressure Drop vs. Flow characteristic

Oil viscosity 46 cSt @ 45°C

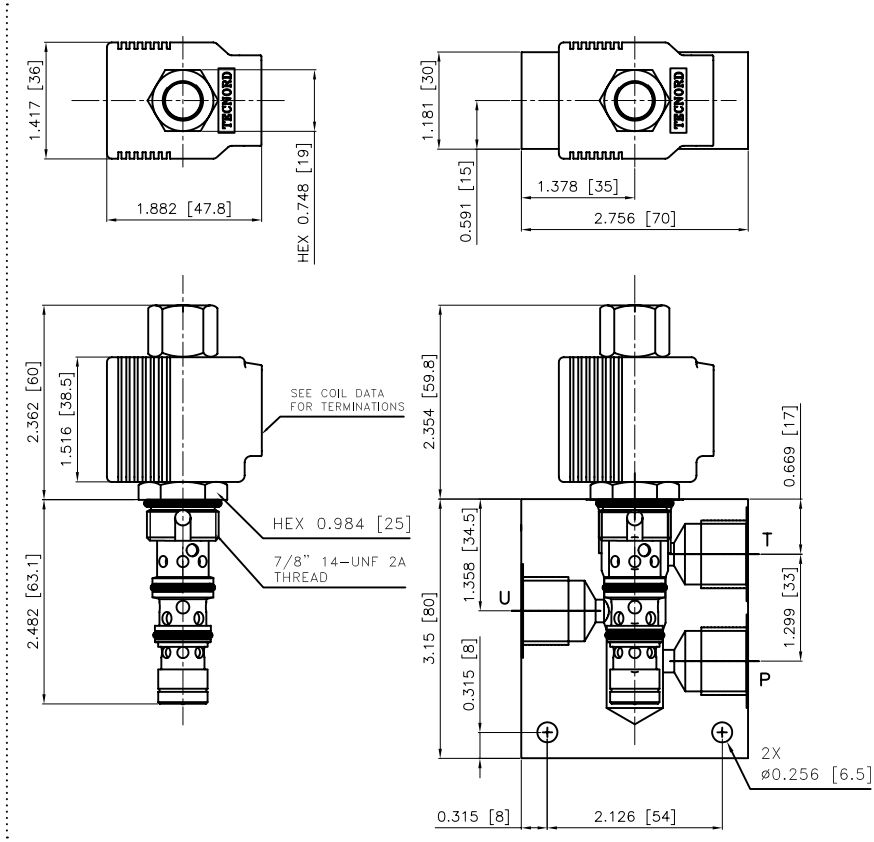
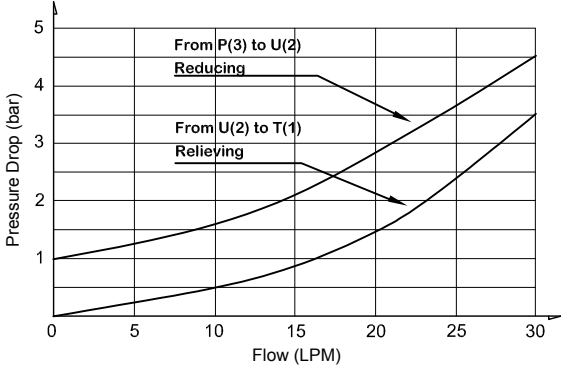

ORDERING INFORMATION

Approximate Coil Weight: .42 lbs (.19 kg)

<p><b>EG-TRZ-42-H -</b></p> <p>—</p> <p><b>MAX REGULATED PRESSURE</b></p> <p>140 bar</p> <p>210 bar</p>	<p>—</p> <p><b>OPTIONS</b></p> <p>00 - Polyurethane Standard</p>	<p>—</p> <p><b>“PJ” COIL TERMINATION</b></p> <p>JH - DIN 43650 (Hirschmann)</p> <p>JA - AMP Superseal</p> <p>JD - Deutsch DT04-2P</p> <p>JJ - AMP Jr. Timer</p>	<p>—</p> <p><b>VOLTAGE</b></p> <p>12 - 12 VDC</p> <p>24 - 24 VDC</p>	<p>—</p> <p><b>BODIES</b></p> <p>Blank - Without body</p> <p>N - 3/8" BSP Ports</p>
---	--	---	--	---

W 5 / 2018

**WARNING:** the specifications/application data shown in our catalogs and data sheets are intended only as a general guide for the product described (herein). Any specific application should not be undertaken without independent study, evaluation, and testing for suitability.



4484 Boeing Drive Rockford, IL 61109 • USA • Phone +1 (815) 397-6628 • Fax +1 (815) 397-2526  
 mail: delta@delta-power.com • www.delta-power.com



Via Malavolti, 36 • 41122 Modena • ITALY • Phone +39 (059) 254895 • Fax +39 (059) 253512  
 mail: tecnord@tecnord.com • www.tecnord.com

**WARNING:** *the specifications/application data shown in our catalogs and data sheets are intended only as a general guide for the product described (herein). Any specific application should not be undertaken without independent study, evaluation, and testing for suitability.*



4484 Boeing Drive Rockford, IL 61109 • USA • Phone +1 (815) 397-6628 • Fax +1 (815) 397-2526  
mail: [delta@delta-power.com](mailto:delta@delta-power.com) • [www.delta-power.com](http://www.delta-power.com)



Via Malavolti, 36 • 41122 Modena • ITALY • Phone +39 (059) 254895 • Fax +39 (059) 253512  
mail: [tecnord@tecnord.com](mailto:tecnord@tecnord.com) • [www.tecnord.com](http://www.tecnord.com)

**PROPORTIONAL PRESSURE RELIEF VALVES**

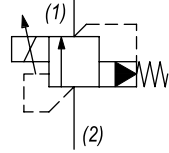
NORMALLY CLOSED	GPM	PSI	LPM	BAR	CAVITY	MODEL	PAGE
	20	3000	76	207	7/8-14	EE-PRB	PT20

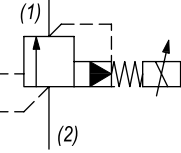
NORMALLY OPEN	GPM	PSI	LPM	BAR	CAVITY	MODEL	PAGE
	12	3000	45	207	7/8-14	EE-PRD	PT22

**TYPICAL SCHEMATIC**

Typical application for the PRL and PRB is for fan or motor speed control.

W 5 / 2018

**WARNING:** the specifications/application data shown in our catalogs and data sheets are intended only as a general guide for the product described (herein). Any specific application should not be undertaken without independent study, evaluation, and testing for suitability.



4484 Boeing Drive Rockford, IL 61109 • USA • Phone +1 (815) 397-6628 • Fax +1 (815) 397-2526  
 mail: delta@delta-power.com • www.delta-power.com



Via Malavolti, 36 • 41122 Modena • ITALY • Phone +39 (059) 254895 • Fax +39 (059) 253512  
 mail: tecnord@tecnord.com • www.tecnord.com

**EE-PRB 2 WAY NORMALLY CLOSED, PROPORTIONAL RELIEF VALVE**

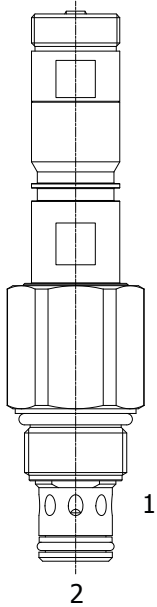

**DESCRIPTION**

10 size, 7/8-14 thread, "Delta" series, solenoid operated, 2 way normally closed, pilot operated spool type relief valve.

**OPERATION**

The EE-PRB blocks flow from (2) to (1) until sufficient pressure is present at (2) to offset a spring induced force. As solenoid current is increased, it offsets a portion of this force, resulting in a lower relief pressure. Can be infinitely adjusted across a prescribed range in response to a PWM (Pulse Width Modulated) current. Pressure output is inversely proportional to the current input. With full current applied to the solenoid, the valve will free flow from (2) to (1), at approximately 100 PSI (7 bar).

*Note: backpressure on port (1) becomes additive to the pressure setting at a 1:1 ratio.*

**FEATURES**

- Efficient wet-armature construction.
- Cartridges are voltage interchangeable.
- Industry common cavity.
- Unitized, molded coil design.
- Continuous duty rated solenoid.
- Optional coil voltages and terminations.



*Great for fan drive motor control.*

**HYDRAULIC SYMBOL**

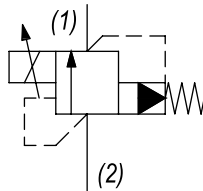

**PERFORMANCE**

**Relief pressure vs. Current**

*Constant flow 10 LPM (2.6 GPM)*

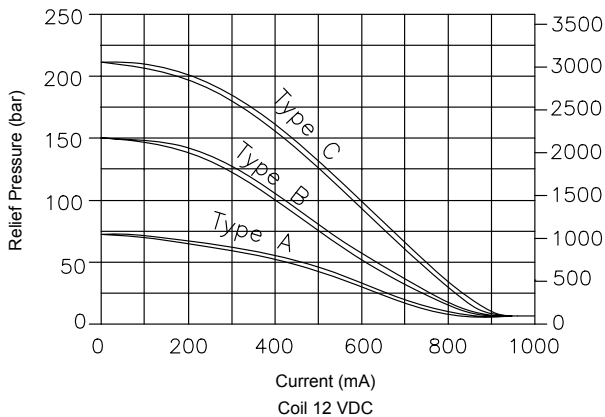

**VALVE SPECIFICATIONS**

Nominal Flow	0+20 GPM (0+76 LPM)
Operating Range	100-3000 PSI (7-207 bar)
Typical Hysteresis	10% Max
Viscosity Range	36 to 3000 SSU (3 to 647 cSt)
Filtration	ISO 18/16/13
Media Operating Temp. Range	-30°C / +100°C
Weight	.62 lbs (.28 kg)
Operating Fluid Media	General Purpose Hydraulic Fluid
Cartridge Torque Requirements	30 ft-lbs (40.6 Nm)
Coil Nut Torque Requirements	2-3 ft-lbs (3-4 Nm)
Cavity	DELTA 2W
Cavity Tools Kit (form tool, reamer, tap)	40500000
Seal Kit	21191202

**COIL SPECIFICATIONS**

Current Supply Characteristics	PWM (Pulse Width Modulation)
Rated Current Range	100+1000 mA
PWM or Super-Imposed	
Dither Frequency	120+200 Hz
Coil Resistance (12 VDC)	7.2 Ohm ±5% at 68°F (20°C)

**WARNING:** the specifications/application data shown in our catalogs and data sheets are intended only as a general guide for the product described (herein). Any specific application should not be undertaken without independent study, evaluation, and testing for suitability.



4484 Boeing Drive Rockford, IL 61109 • USA • Phone +1 (815) 397-6628 • Fax +1 (815) 397-2526  
 mail: delta@delta-power.com • www.delta-power.com



Via Malavolti, 36 • 41122 Modena • ITALY • Phone +39 (059) 254895 • Fax +39 (059) 253512  
 mail: tecnord@tecnord.com • www.tecnord.com

**DIMENSIONS**

**Relief pressure vs. Flow - No current applied**  
 Costant flow 10 LPM (2.6 GPM)

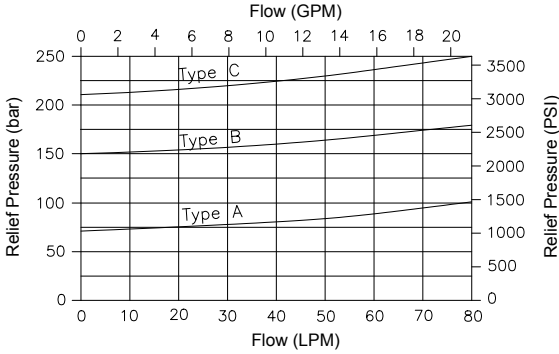

**Pressure Drop vs. Flow**  
 Coil energized

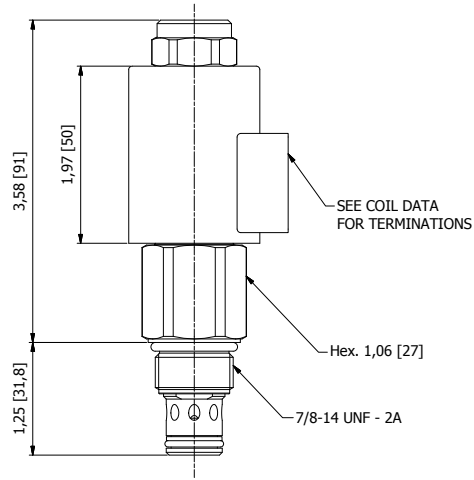
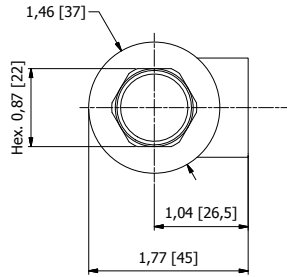
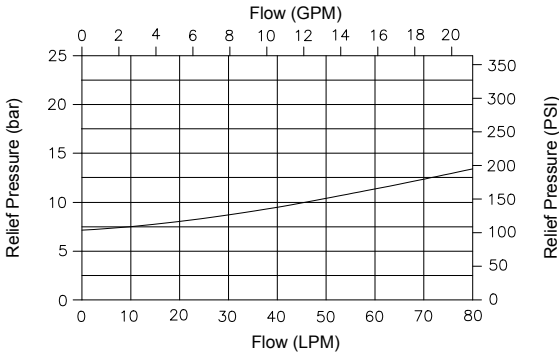

(for bodies style and sizes see section "Accessories")

**ORDERING INFORMATION**

Approximate Coil Weight: .47 lbs (.21 kg)

EE-PRB - - - -

- OPTIONS**
- Buna, 100-1015 PSI range (7-70 bar) **0A**
  - Viton, 100-1015 PSI range (7-70 bar) **VA**
  
  - Buna, 100-2175 PSI range (7-150 bar) **0B**
  - Viton, 100-2175 PSI range (7-150 bar) **VB**
  
  - Buna, 100-3000 PSI range (7-207 bar) **0C**
  - Viton, 100-3000 PSI range (7-207 bar) **VC**

- BODIES**
- Blank Without Body
  - N** 3/8" BSP Ports
  - S** #8 SAE Ports

- VOLTAGE** (other voltages available on request)
- 12** 12 VDC
  - 24** 24 VDC

**"F" COIL TERMINATION**

- DIN 43650 (Hirschmann) **HC**
- Deutsch - Integral DT04-2P **DI**
- AMP Jr. Timer **JT**

W 5 / 2018

**WARNING:** the specifications/application data shown in our catalogs and data sheets are intended only as a general guide for the product described (herein). Any specific application should not be undertaken without independent study, evaluation, and testing for suitability.



4484 Boeing Drive Rockford, IL 61109 • USA • Phone +1 (815) 397-6628 • Fax +1 (815) 397-2526  
 mail: delta@delta-power.com • www.delta-power.com



Via Malavolti, 36 • 41122 Modena • ITALY • Phone +39 (059) 254895 • Fax +39 (059) 253512  
 mail: tecnord@tecnord.com • www.tecnord.com

**EE-PRD 2 WAY NORMALLY OPEN, PROPORTIONAL RELIEF VALVE**

**DESCRIPTION**

10 size, 7/8-14 thread, "Delta" series, solenoid operated, 2 way normally open, hydraulic relief valve.

**OPERATION**

The EE-PRD blocks flow from (2) to (1) until sufficient pressure is present at (2) to offset the electrically induced solenoid force. Can be infinitely adjusted across a prescribed range using a variable electric input.

Pressure output is proportional to DC current input. This valve is intended for use as a pressure limiting device in demanding applications.

With no current applied to the solenoid, the valve will free flow from (2) to (1) at approximately 50 PSI.

*Note: backpressure on port (1) becomes additive to the pressure setting at a 1:1 ratio.*

**FEATURES**

- Efficient wet-armature construction.
- Cartridges are voltage interchangeable.
- Industry common cavity.
- Unitized, molded coil design.
- Continuous duty rated solenoid.
- Optional coil voltages and terminations.

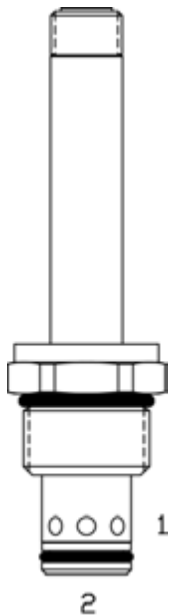

*If low voltage is expected on the machine, 12 or 24 volt systems will require the use of 10 volt or 20 volt coils respectively. Consult Factory for availability of these coil options.*



*For best performance valve must be purged of air. Locate below reservoir or add check valve to return. Recommended vehicle installation is Tube Up or Horizontal after purging. Fastest purging position during bleed/start-up is with tube up. PWM frequency: 100-200 Hz (200 Hz recommended). For lower minimum or other ranges consult factory.*

**HYDRAULIC SYMBOL**

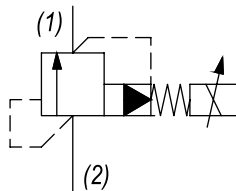

**PERFORMANCE**

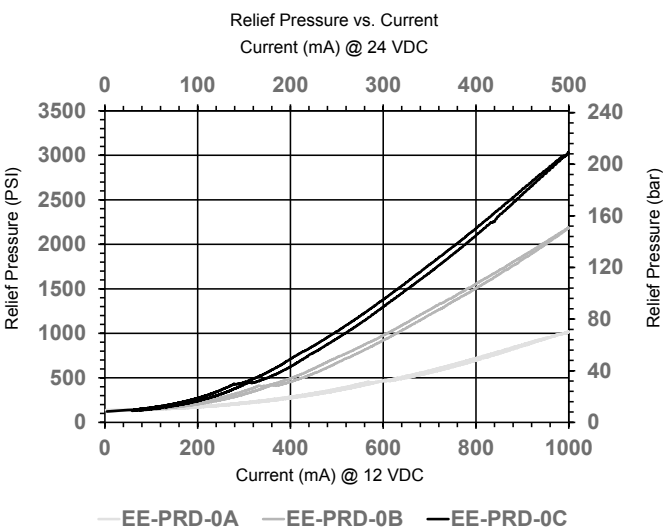

**VALVE SPECIFICATIONS**

Nominal Flow	0-20 GPM (0-76 LPM)
Operating Range	50-3000 PSI (3-207 bar)
Typical Hysteresis	5%
Viscosity Range	36 to 3000 SSU (3 to 647 cSt)
Filtration	ISO 18/16/13
Media Operating Temp. Range	-40°C to 250°F (-40°C to 120°C)
Weight	.30 lbs (.13 kg)
Operating Fluid Media	General Purpose Hydraulic Fluid
Cartridge Torque Requirements	30 ft-lbs (40.6 Nm)
Coil Nut Torque Requirements	4-6 ft-lbs (5.4-8.1 Nm)
Cavity	DELTA 2W
Cavity Tools Kit	
(form tool, reamer, tap)	40500000
Seal Kit	21191202

**WARNING:** the specifications/application data shown in our catalogs and data sheets are intended only as a general guide for the product described (herein). Any specific application should not be undertaken without independent study, evaluation, and testing for suitability.



4484 Boeing Drive Rockford, IL 61109 • USA • Phone +1 (815) 397-6628 • Fax +1 (815) 397-2526  
mail: delta@delta-power.com • www.delta-power.com



Via Malavolti, 36 • 41122 Modena • ITALY • Phone +39 (059) 254895 • Fax +39 (059) 253512  
mail: tecnord@tecnord.com • www.tecnord.com

**DIMENSIONS**

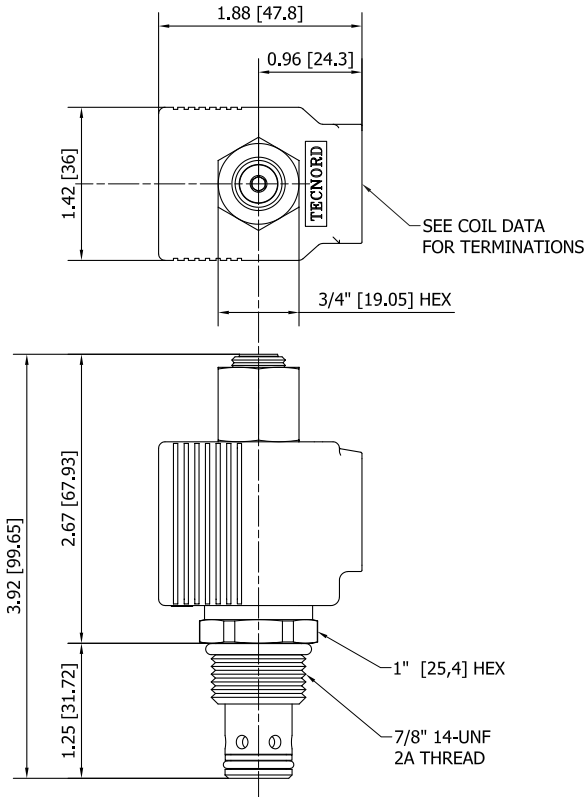
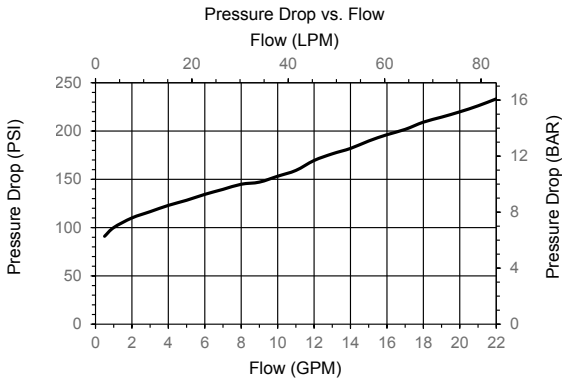
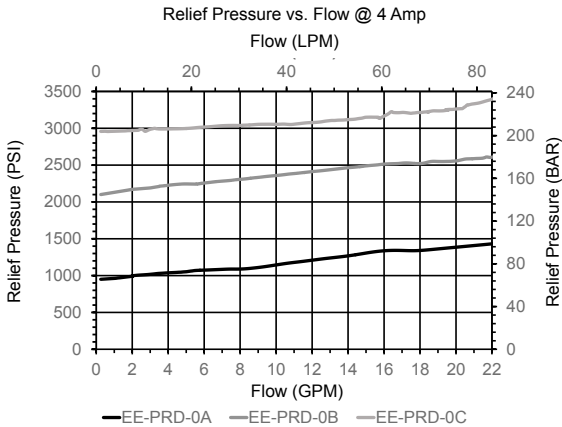

(for bodies style and sizes see section "Accessories")

**ORDERING INFORMATION**

Approximate Coil Weight: .74 lbs (.33 kg)

<p><b>EE-PRD</b> - - - -</p> <p><b>OPTIONS</b></p> <p>Buna, 100-1020 PSI range    <b>0A</b></p> <p>Viton, 100-1020 PSI range    <b>VA</b></p> <p>Buna, 100-2175 PSI range    <b>0B</b></p> <p>Viton, 100-2175 PSI range    <b>VB</b></p> <p>Buna, 100-3000 PSI range    <b>0C</b></p> <p>Viton, 100-3000 PSI range    <b>VC</b></p>	<p><b>BODIES</b></p> <p><b>Blank</b> Without Body</p> <p><b>N</b> 3/8" BSP Ports</p> <p><b>S</b> #8 SAE Ports</p>	<p><b>VOLTAGE</b></p> <p><b>12</b> 12 VDC</p> <p><b>24</b> 24 VDC</p>
<p><b>"PJ" COIL TERMINATION</b></p> <p><b>JH</b> DIN 43650 (Hirschmann)</p> <p><b>JA</b> AMP Superseal</p> <p><b>JD</b> Deutsch DT04-2P</p> <p><b>JJ</b> AMP Jr. Timer</p>		

W 48 / 2018

**WARNING:** the specifications/application data shown in our catalogs and data sheets are intended only as a general guide for the product described (herein). Any specific application should not be undertaken without independent study, evaluation, and testing for suitability.



4484 Boeing Drive Rockford, IL 61109 • USA • Phone +1 (815) 397-6628 • Fax +1 (815) 397-2526  
 mail: delta@delta-power.com • www.delta-power.com



Via Malavolti, 36 • 41122 Modena • ITALY • Phone +39 (059) 254895 • Fax +39 (059) 253512  
 mail: tecnord@tecnord.com • www.tecnord.com

**WARNING:** *the specifications/application data shown in our catalogs and data sheets are intended only as a general guide for the product described (herein). Any specific application should not be undertaken without independent study, evaluation, and testing for suitability.*



4484 Boeing Drive Rockford, IL 61109 • USA • Phone +1 (815) 397-6628 • Fax +1 (815) 397-2526  
mail: [delta@delta-power.com](mailto:delta@delta-power.com) • [www.delta-power.com](http://www.delta-power.com)



Via Malavolti, 36 • 41122 Modena • ITALY • Phone +39 (059) 254895 • Fax +39 (059) 253512  
mail: [tecnord@tecnord.com](mailto:tecnord@tecnord.com) • [www.tecnord.com](http://www.tecnord.com)



**2 WAY NORMALLY CLOSED PROPORTIONAL FLOW CONTROL VALVES**

SPOOL TYPE	GPM	PSI	LPM	BAR	CAVITY	MODEL	PAGE
	13.2	3500	50	241	7/8-14	<b>EE-P2G</b>	PT26
	23.7	3500	90	241	1 1/16-12	<b>ET-P2S</b>	PT28

POPPET TYPE	GPM	PSI	LPM	BAR	CAVITY	MODEL	PAGE
	6.5	3500	25	241	3/4-16	<b>EB-P2A</b>	PT30
	12	3500	45	241	7/8-14	<b>EE-P2A</b>	PT32
	29	3500	110	241	1 1/16-12	<b>ET-P2A</b>	PT34

W 5 / 2018

**WARNING:** the specifications/application data shown in our catalogs and data sheets are intended only as a general guide for the product described (herein). Any specific application should not be undertaken without independent study, evaluation, and testing for suitability.



4484 Boeing Drive Rockford, IL 61109 • USA • Phone +1 (815) 397-6628 • Fax +1 (815) 397-2526  
 mail: delta@delta-power.com • www.delta-power.com



Via Malavolti, 36 • 41122 Modena • ITALY • Phone +39 (059) 254895 • Fax +39 (059) 253512  
 mail: tecnord@tecnord.com • www.tecnord.com

**EE-P2G 2 WAY NORMALLY CLOSED, PROPORTIONAL FLOW CONTROL VALVE**

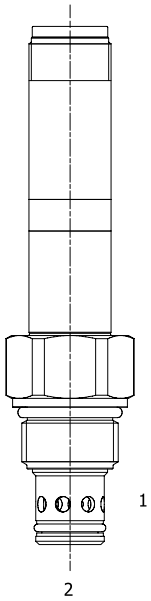

**DESCRIPTION**

10 size, 7/8-14 thread, "Delta" series, solenoid operated, 2 way normally closed, proportional flow control valve.

**OPERATION**

When de-energized the EE-P2G blocks flow at ports (1) and (2). When energized, the valve allows flow from (2) to (1). Flow is proportional to the current applied to the coil. A compensator must be used to create a pressure compensated flow control function.

**OPERATION OF MANUAL OVERRIDE OPTION:** to override, turn the manual override screw clockwise. To release turn the manual override screw counterclockwise.

**FEATURES**

- Efficient wet-armature construction.
- Cartridges are voltage interchangeable.
- Industry common cavity.
- Unitized, molded coil design.
- Continuous duty rated solenoid.
- Optional coil voltages and terminations.



*Curves are attained with Tecnord QC-CP3 compensator.*

**HYDRAULIC SYMBOL**

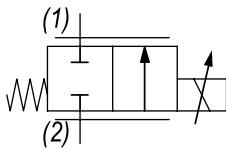

**PERFORMANCE**

**Flow vs. Current - "A" Version**

Coil 12 VDC - Delta P = 14 bar - Oil 26 cSt (121 SSU) @ 50°C (104°F)

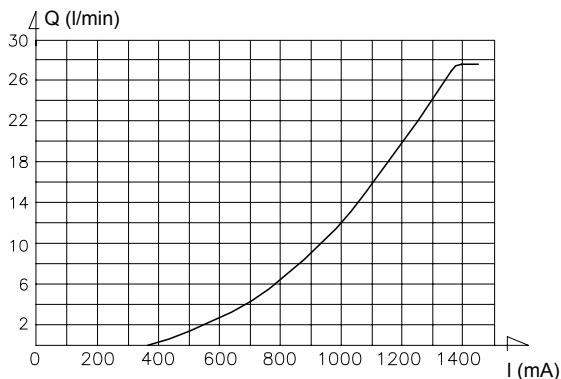

**VALVE SPECIFICATIONS**

Flow Range	See curves for various versions
Max System Pressure	3500 PSI (241 bar)
Leakage	Max 50 cc/min at 245 bar
Hysteresis	±3%
Viscosity Range	36 to 3000 SSU (3 to 647 cSt)
Filtration	ISO 18/16/13
Media Operating Temp. Range	-30°C / +100°C
Weight	.58 lbs (.26 kg)
Operating Fluid Media	General Purpose Hydraulic Fluid
Cartridge Torque Requirements	26 ft-lbs (35 Nm)
Coil Nut Torque Requirements	2-3 ft-lbs (3-4 Nm)
Cavity	DELTA 2W
Cavity Tools Kit (form tool, reamer, tap)	40500000
Seal Kit	21191200

**COIL SPECIFICATIONS**

Current Supply Characteristics	PWM (Pulse Width Modulation)
Rated Current Range	400-1400 mA
PWM or Super-Imposed	
Dither Frequency	100-150 Hz
Coil Resistance (12 VDC)	7.2 Ohm ±5% at 68°F (20°C)

**WARNING:** the specifications/application data shown in our catalogs and data sheets are intended only as a general guide for the product described (herein). Any specific application should not be undertaken without independent study, evaluation, and testing for suitability.



4484 Boeing Drive Rockford, IL 61109 • USA • Phone +1 (815) 397-6628 • Fax +1 (815) 397-2526  
mail: delta@delta-power.com • www.delta-power.com



Via Malavolti, 36 • 41122 Modena • ITALY • Phone +39 (059) 254895 • Fax +39 (059) 253512  
mail: tecnord@tecnord.com • www.tecnord.com

**DIMENSIONS**

**Flow vs. Current - "B" Version**

Coil 12 VDC - Delta P = 14 bar - Oil 26 cSt (121 SSU) @ 50°C (104°F)

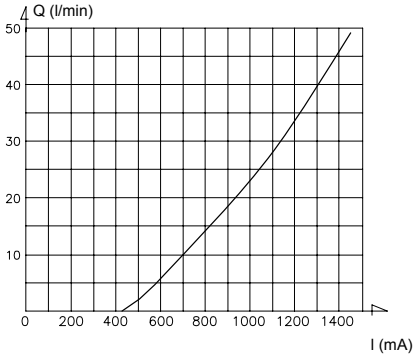

**Flow vs. Current - "C" Version**

Coil 12 VDC - Delta P = 14 bar - Oil 26 cSt (121 SSU) @ 50°C (104°F)

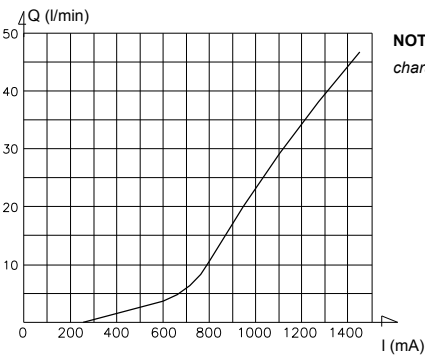

NOTE: non linear characteristics

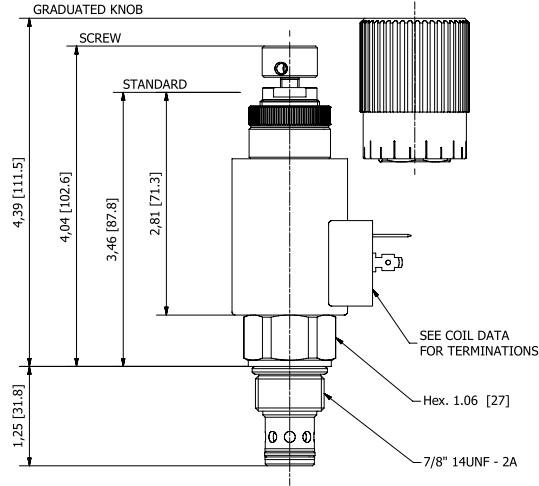
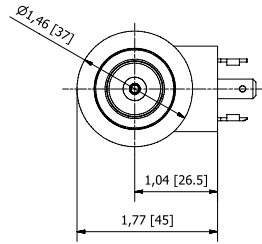

(for bodies style and sizes see section "Accessories")

**ORDERING INFORMATION**

Approximate Coil Weight: .47 lbs (.21 kg)

EE-P2G - - - -

**OPTIONS**

- Buna, Push Type Override Standard **AP** Up to 22 l/min
- Buna, Screw Type Override (Knob) **AS** Up to 22 l/min
- Buna, Screw Type Override (Grad. Knob) **AK** Up to 22 l/min
  
- Buna, Push Type Override Standard **BP** Up to 50 l/min
- Buna, Screw Type Override (Knob) **BS** Up to 50 l/min
- Buna, Screw Type Override (Grad. Knob) **BK** Up to 50 l/min
  
- Buna, Push Type Override Standard **CP** Up to 50 l/min
- Buna, Screw Type Override (Knob) **CS** Up to 50 l/min
- Buna, Screw Type Override (Grad. Knob) **CK** Up to 50 l/min

**BODIES**

- Blank** Without Body
- N** 3/4" BSP Ports
- S** #8 SAE Ports

**VOLTAGE**

- 12** 12 VDC
- 24** 24 VDC

**"F" COIL TERMINATION**

- HC** DIN 43650 (Hirschmann)
- DI** Deutsch-Integral DT04-2P
- JT** AMP Jr. Timer

NOTES: 1) Flows refer to a 14 bar Delta P  
2) For other seals, consult factory

WARNING: the specifications/application data shown in our catalogs and data sheets are intended only as a general guide for the product described (herein). Any specific application should not be undertaken without independent study, evaluation, and testing for suitability.

W 5 / 2018



4484 Boeing Drive Rockford, IL 61109 • USA • Phone +1 (815) 397-6628 • Fax +1 (815) 397-2526  
mail: delta@delta-power.com • www.delta-power.com



Via Malavolti, 36 • 41122 Modena • ITALY • Phone +39 (059) 254895 • Fax +39 (059) 253512  
mail: tecnord@tecnord.com • www.tecnord.com

**ET-P2S 2 WAY NORMALLY CLOSED, PROPORTIONAL FLOW CONTROL VALVE**

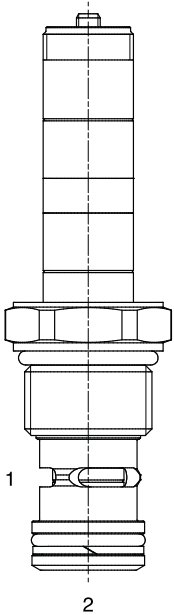

**DESCRIPTION**

12 size, 1 1/16-12 thread, "Tecnord" series, solenoid operated, 2 way normally closed, proportional flow control valve.

**OPERATION**

When de-energized the ET-P2S blocks flow at ports (2) and (1). When energized, the valve allows flow from (1) to (2). Flow is proportional to the current applied to the coil. A compensator must be used to create a pressure compensated flow control function.

**OPERATION OF MANUAL OVERRIDE OPTION:** to override, turn the manual override screw counterclockwise. To release turn the manual override screw clockwise.

**FEATURES**

- Efficient wet-armature construction.
- Cartridges are voltage interchangeable.
- Industry common cavity.
- Unitized, molded coil design.
- Continuous duty rated solenoid.
- Optional coil voltages and terminations.



*Curves are attained with Tecnord QC-CP3 compensator.*

**HYDRAULIC SYMBOL**

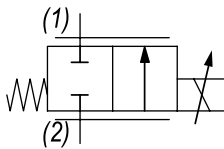

**PERFORMANCE**

**Flow vs. Current**

Coil 12 VDC - Press. Drop = 14 bar - Oil 46 cSt (217 SSU) @ 50°C (122°F)

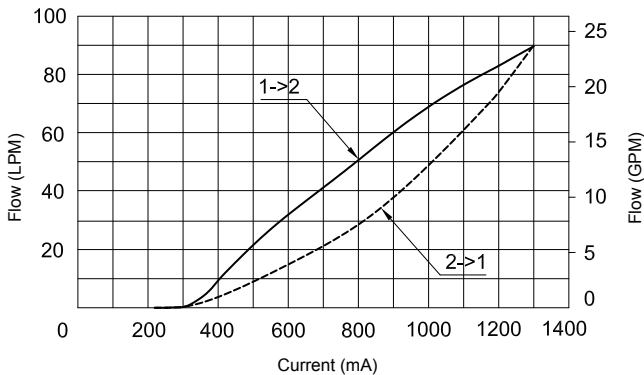

**VALVE SPECIFICATIONS**

Flow Range	See curves for various versions
Max System Pressure	3500 PSI (241 bar)
Leakage	Max 50 cc/min at 245 bar
Hysteresis	±3%
Viscosity Range	36 to 3000 SSU (3 to 647 cSt)
Filtration	ISO 18/16/13
Media Operating Temp. Range	-30°C / +100°C
Weight	.72 lbs (.32 kg)
Operating Fluid Media	General Purpose Hydraulic Fluid
Cartridge Torque Requirements	37 ft-lbs (50 Nm)
Coil Nut Torque Requirements	2-3 ft-lbs (3-4 Nm)
Cavity	TECNORD 2W
Cavity Tools Kit (form tool, reamer, tap)	40500032
Seal Kit	21191200

**COIL SPECIFICATIONS**

Current Supply Characteristics	PWM (Pulse Width Modulation)
Rated Current Range	400-1400 mA
PWM or Super-Imposed	
Dither Frequency	100-150 Hz
Coil Resistance (12 VDC)	7.2 Ohm ±5% at 68°F (20°C)

**WARNING:** the specifications/application data shown in our catalogs and data sheets are intended only as a general guide for the product described (herein). Any specific application should not be undertaken without independent study, evaluation, and testing for suitability.



4484 Boeing Drive Rockford, IL 61109 • USA • Phone +1 (815) 397-6628 • Fax +1 (815) 397-2526  
mail: delta@delta-power.com • www.delta-power.com



Via Malavolti, 36 • 41122 Modena • ITALY • Phone +39 (059) 254895 • Fax +39 (059) 253512  
mail: tecnord@tecnord.com • www.tecnord.com

**DIMENSIONS**

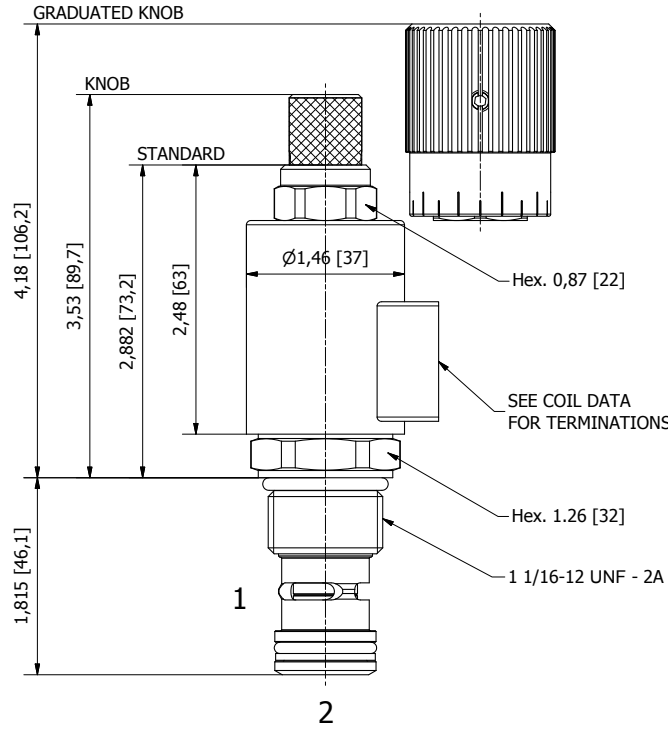
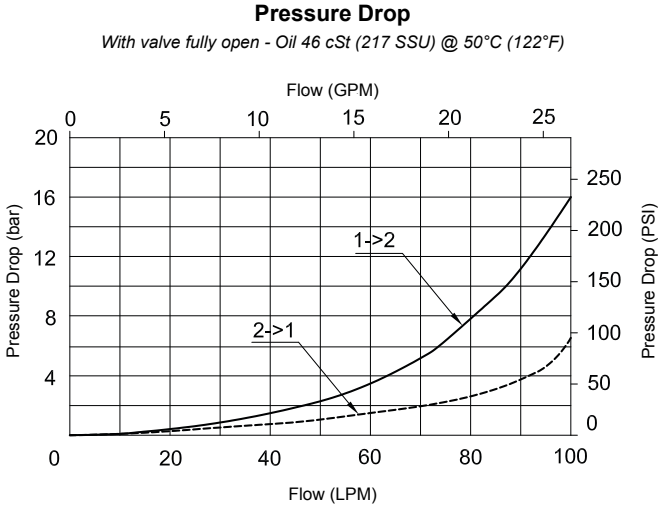

(for bodies style and sizes see section "Accessories")

**ORDERING INFORMATION**

Approximate Coil Weight: .47 lbs (.21 kg)

**ET-P2S - - - -**

<p><b>OPTIONS</b></p> <p>Buna Standard <b>C0</b> Up to 90 l/min          Buna, Screw Type Override (Knob) <b>CS</b> Up to 90 l/min          Buna, Screw Type Override (Grad. Knob) <b>CK</b> Up to 90 l/min</p>	<p><b>BODIES</b></p> <p><b>Blank</b> Without Body  <b>N</b> 3/4" BSP Ports  <b>S</b> #8 SAE Ports</p>	<p><b>VOLTAGE</b></p> <p><b>12</b> 12 VDC  <b>24</b> 24 VDC</p>
<p><b>"F" COIL TERMINATION</b></p> <p><b>HC</b> DIN 43650 (Hirschmann)  <b>DI</b> Deutsch-Integral DT04-2P  <b>JT</b> AMP Jr. Timer</p>		

**NOTES:** 1) Flows refer to a 14 bar Delta P  
 2) For other seals, consult factory

WARNING: the specifications/application data shown in our catalogs and data sheets are intended only as a general guide for the product described (herein). Any specific application should not be undertaken without independent study, evaluation, and testing for suitability.



4484 Boeing Drive Rockford, IL 61109 • USA • Phone +1 (815) 397-6628 • Fax +1 (815) 397-2526  
 mail: delta@delta-power.com • www.delta-power.com



Via Malavolti, 36 • 41122 Modena • ITALY • Phone +39 (059) 254895 • Fax +39 (059) 253512  
 mail: tecnord@tecnord.com • www.tecnord.com

**EB-P2A 2 WAY NORMALLY CLOSED, PROPORTIONAL FLOW CONTROL VALVE**

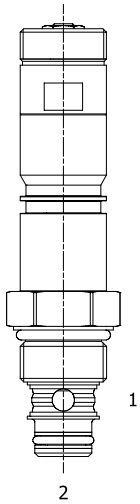

**DESCRIPTION**

8 size, 3/4-16 thread, solenoid operated, 2 way normally closed poppet style, proportional flow control valve.

**OPERATION**

When de-energized the EB-P2A blocks flow from (1) to (2) and allows reverse flow from (2) to (1). When energized, the valve allows flow from (1) to (2). Flow is proportional to current applied to the coil. A compensator must be used to create a pressure compensated flow control function.

**FEATURES**

- Efficient wet-armature construction.
- Cartridges are voltage interchangeable.
- Industry common cavity.
- Unitized, molded coil design.
- Continuous duty rated solenoid.
- Optional coil voltages and terminations.



Curves are attained without pressure compensator. The valve can work with a pressure drop up to 200 bar.

**HYDRAULIC SYMBOL**

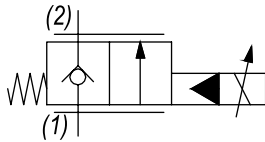

**PERFORMANCE**

**Pressure Drop**

1 to 2 with valve completely open

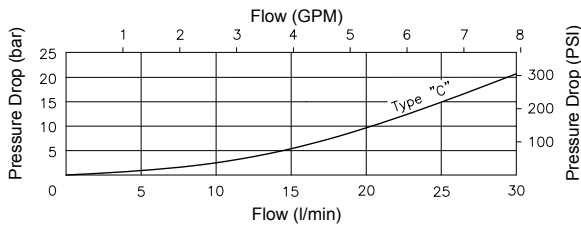

**Flow vs. Current at different Pressure Drop**

Coil 12 VDC - hyd. - Oil 26 cSt (121 SSU) @ 40°C (104°F)

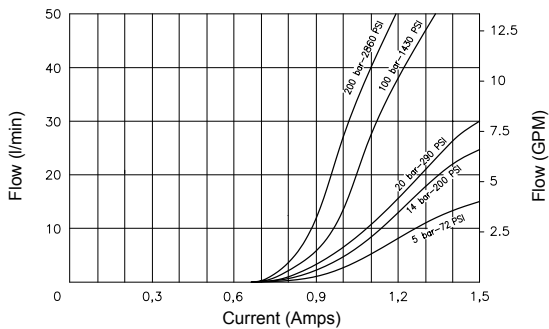

**VALVE SPECIFICATIONS**

Flow Range	See curves
Max System Pressure	3500 PSI (241 bar)
Leakage	0-10 drops / min @ 245 bar
Hysteresis	±3%
Viscosity Range	36 to 3000 SSU (3 to 647 cSt)
Filtration	ISO 18/16/13
Media Operating Temp. Range	-30°C / +100°C
Weight	.72 lbs (.32 kg)
Operating Fluid Media	General Purpose Hydraulic Fluid
Cartridge Torque Requirements	19 ft-lbs (25 Nm)
Coil Nut Torque Requirements	2-3 ft-lbs (3-4 Nm)
Cavity	POWER 2W
Cavity Tools Kit (form tool, reamer, tap)	40500005
Seal Kit	21191102

**COIL SPECIFICATIONS**

Current Supply Characteristics	PWM (Pulse Width Modulation)
Rated Current Range	400-1400 mA
PWM or Super-Imposed	
Dither Frequency	100 Hz
Coil Resistance (12 VDC)	7.2 Ohm ±5% at 68°F (20°C)

**WARNING:** the specifications/application data shown in our catalogs and data sheets are intended only as a general guide for the product described (herein). Any specific application should not be undertaken without independent study, evaluation, and testing for suitability.



4484 Boeing Drive Rockford, IL 61109 • USA • Phone +1 (815) 397-6628 • Fax +1 (815) 397-2526  
 mail: delta@delta-power.com • www.delta-power.com



Via Malavolti, 36 • 41122 Modena • ITALY • Phone +39 (059) 254895 • Fax +39 (059) 253512  
 mail: tecnord@tecnord.com • www.tecnord.com

**DIMENSIONS**

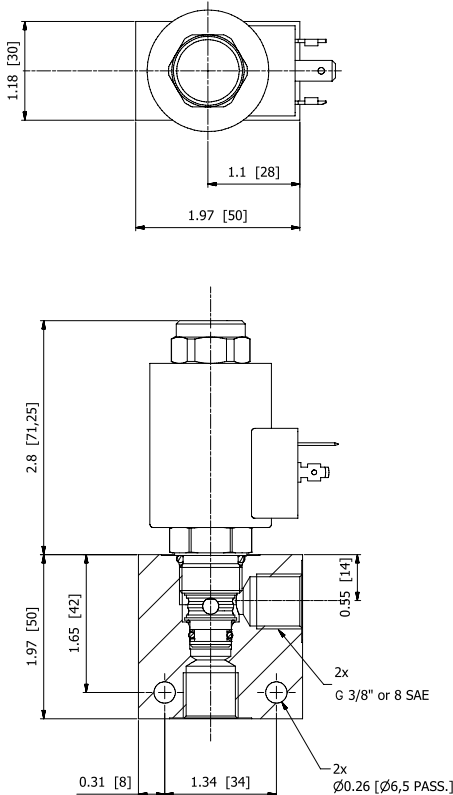
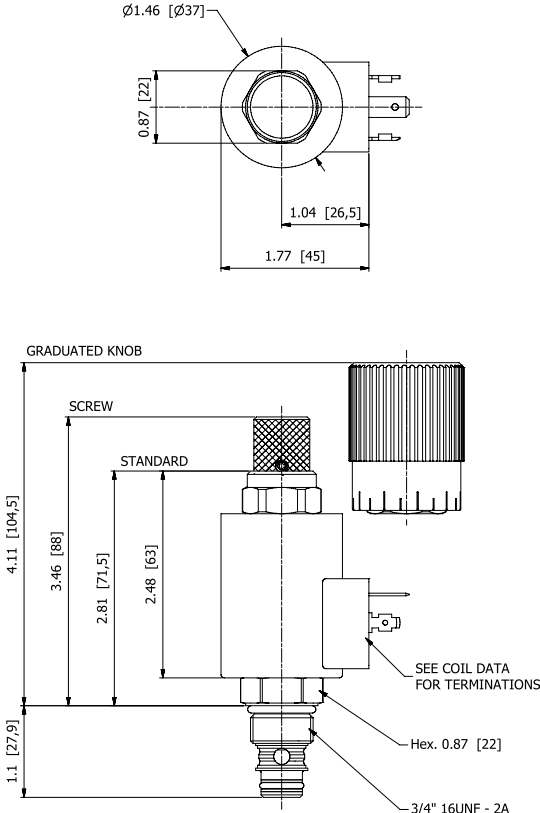

(for bodies style and sizes see section "Accessories")

**ORDERING INFORMATION**

Approximate Coil Weight: .47 lbs (.21 kg)

**EB-P2A** - - - -

- OPTIONS**  
 Buna Standard **C0** Up to 25 l/min  
 Buna, Screw Type Override (Knob) **CS** Up to 25 l/min  
 Buna, Screw Type Override (Grad. Knob) **CK** Up to 25 l/min

- BODIES**  
**Blank** Without Body  
**N** 3/8" BSP Ports  
**S** #8 SAE Ports

- VOLTAGE**  
**12** 12 VDC  
**24** 24 VDC

**"F" COIL TERMINATION**

- HC** DIN 43650 (Hirschmann)  
**DI** Deutsch-Integral DT04-2P  
**JT** AMP Jr. Timer

**NOTES:** 1) Flows refer to a 14 bar Delta P  
 2) For other seals, consult factory

W 5 / 2018

**WARNING:** the specifications/application data shown in our catalogs and data sheets are intended only as a general guide for the product described (herein). Any specific application should not be undertaken without independent study, evaluation, and testing for suitability.



4484 Boeing Drive Rockford, IL 61109 • USA • Phone +1 (815) 397-6628 • Fax +1 (815) 397-2526  
 mail: delta@delta-power.com • www.delta-power.com



Via Malavolti, 36 • 41122 Modena • ITALY • Phone +39 (059) 254895 • Fax +39 (059) 253512  
 mail: tecnord@tecnord.com • www.tecnord.com

**EE-P2A 2 WAY NORMALLY CLOSED, PROPORTIONAL FLOW CONTROL VALVE**

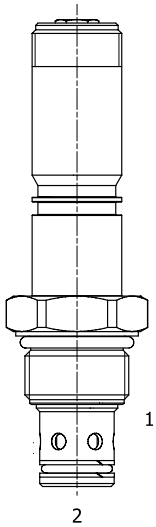

**DESCRIPTION**

10 size, 7/8-14 thread, solenoid operated, 2 way normally closed poppet style, proportional flow control valve.

**OPERATION**

When de-energized the EE-P2A blocks flow from (1) to (2) and allows reverse flow from (2) to (1). When energized, the valve allows flow from (1) to (2). Flow is proportional to current applied to the coil. A compensator must be used to create a pressure compensated flow control function.

**FEATURES**

- Efficient wet-armature construction.
- Cartridges are voltage interchangeable.
- Industry common cavity.
- Unitized, molded coil design.
- Continuous duty rated solenoid.
- Optional coil voltages and terminations.



*Curves are attained without pressure compensator. The valve can work with a pressure drop up to 200 bar.*

**HYDRAULIC SYMBOL**

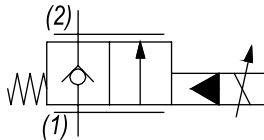

**PERFORMANCE**

**Pressure Drop**

1 to 2 with valve completely open

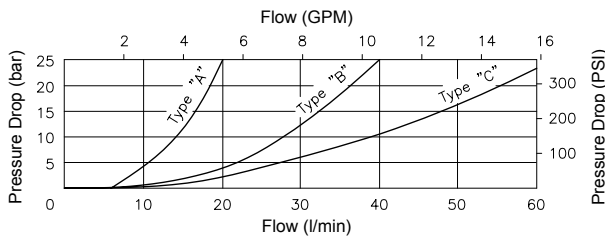

**Flow vs. Current at different Pressure Drop**

Poppet type A - Coil 12 VDC - hyd. oil 26 cSt (121 SSU) @ 40°C (104°F)

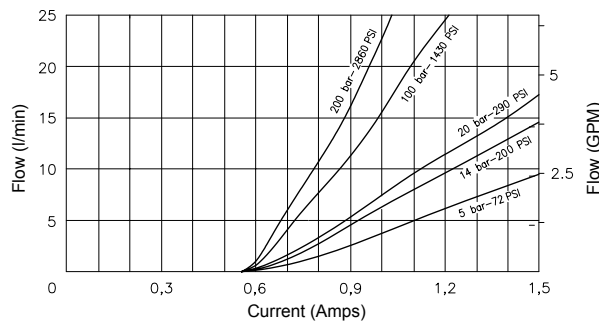

**VALVE SPECIFICATIONS**

Flow Range	See curves for various versions
Max System Pressure	3500 PSI (241 bar)
Leakage	0-10 drops / min @ 245 bar
Hysteresis	±3%
Viscosity Range	36 to 3000 SSU (3 to 647 cSt)
Filtration	ISO 18/16/13
Media Operating Temp. Range	-30°C / +100°C
Weight	.72 lbs (.32 kg)
Operating Fluid Media	General Purpose Hydraulic Fluid
Cartridge Torque Requirements	26-35 ft-lbs (50 Nm)
Coil Nut Torque Requirements	2-3 ft-lbs (3-4 Nm)
Cavity	DELTA 2W
Cavity Tools Kit (form tool, reamer, tap)	40500000
Seal Kit	21191200

**COIL SPECIFICATIONS**

Current Supply Characteristics	PWM (Pulse Width Modulation)
Rated Current Range	400-1400 mA
PWM or Super-Imposed	
Dither Frequency	100 Hz
Coil Resistance (12 VDC)	7.2 Ohm ±5% at 68°F (20°C)

**WARNING:** the specifications/application data shown in our catalogs and data sheets are intended only as a general guide for the product described (herein). Any specific application should not be undertaken without independent study, evaluation, and testing for suitability.



4484 Boeing Drive Rockford, IL 61109 • USA • Phone +1 (815) 397-6628 • Fax +1 (815) 397-2526  
mail: delta@delta-power.com • www.delta-power.com



Via Malavolti, 36 • 41122 Modena • ITALY • Phone +39 (059) 254895 • Fax +39 (059) 253512  
mail: tecnord@tecnord.com • www.tecnord.com



**DIMENSIONS**

**Flow vs. Current at different Pressure Drop**

**Poppet type B - Coil 12 VDC - hyd. oil 26 cSt (121 SSU) @ 40°C (104°F)**

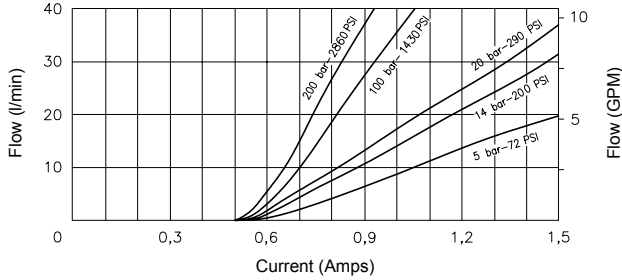

**Flow vs. Current at different Pressure Drop**

**Poppet type C - Coil 12 VDC - hyd. oil 26 cSt (121 SSU) @ 40°C (104°F)**

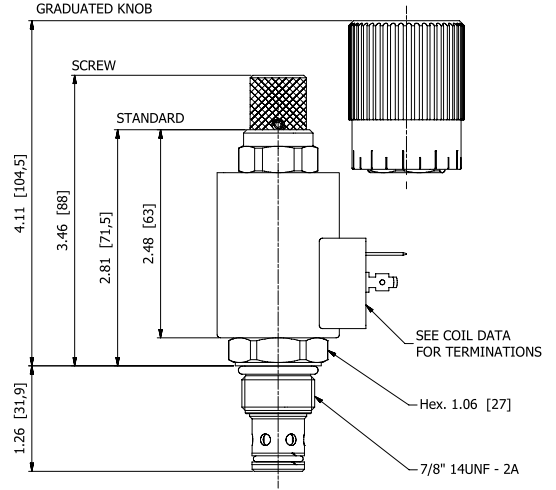
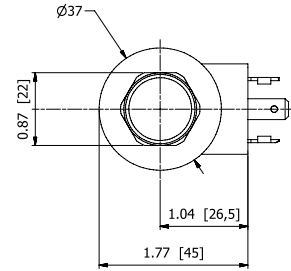
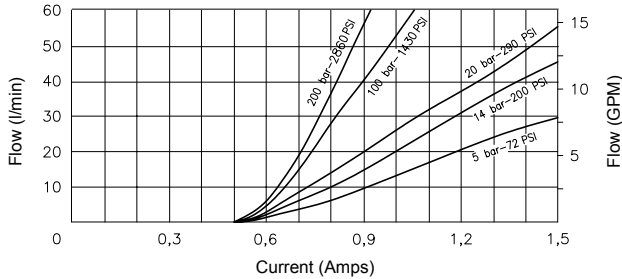

(for bodies style and sizes see section "Accessories")

**ORDERING INFORMATION**

Approximate Coil Weight: .47 lbs (.21 kg)

**EE-P2A - - - -**

**OPTIONS**

- Buna Standard **A0** Up to 15 l/min
- Buna, Screw Type Override (Knob) **AS** Up to 15 l/min
- Buna, Screw Type Override (Grad. Knob) **AK** Up to 15 l/min
  
- Buna Standard **B0** Up to 30 l/min
- Buna, Screw Type Override (Knob) **BS** Up to 30 l/min
- Buna, Screw Type Override (Grad. Knob) **BK** Up to 30 l/min
  
- Buna Standard **C0** Up to 45 l/min
- Buna, Screw Type Override (Knob) **CS** Up to 45 l/min
- Buna, Screw Type Override (Grad. Knob) **CK** Up to 45 l/min

**BODIES**

- Blank** Without Body
- N** 3/4" BSP Ports
- S** #8 SAE Ports

**VOLTAGE**

- 12** 12 VDC
- 24** 24 VDC

**"F" COIL TERMINATION**

- HC** DIN 43650 (Hirschmann)
- DI** Deutsch-Integral DT04-2P
- JT** AMP Jr. Timer

**NOTES:** 1) Flows refer to a 14 bar Delta P  
2) For other seals, consult factory

**WARNING:** the specifications/application data shown in our catalogs and data sheets are intended only as a general guide for the product described (herein). Any specific application should not be undertaken without independent study, evaluation, and testing for suitability.



4484 Boeing Drive Rockford, IL 61109 • USA • Phone +1 (815) 397-6628 • Fax +1 (815) 397-2526  
mail: delta@delta-power.com • www.delta-power.com



Via Malavolti, 36 • 41122 Modena • ITALY • Phone +39 (059) 254895 • Fax +39 (059) 253512  
mail: tecnord@tecnord.com • www.tecnord.com

**ET-P2A 2 WAY NORMALLY CLOSED, PROPORTIONAL FLOW CONTROL VALVE**

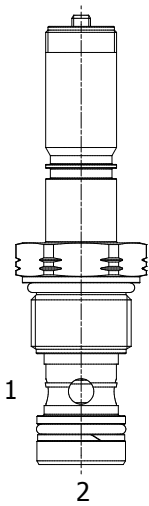

**DESCRIPTION**

12 size, 1 1/16-12 thread, solenoid operated, 2 way normally closed poppet style, proportional flow control valve.

**OPERATION**

When de-energized the ET-P2A blocks flow from (1) to (2) and allows reverse flow from (2) to (1). When energized, the valve allows flow from (1) to (2). Flow is proportional to current applied to the coil. A compensator must be used to create a pressure compensated flow control function.

**FEATURES**

- Efficient wet-armature construction.
- Cartridges are voltage interchangeable.
- Industry common cavity.
- Unitized, molded coil design.
- Continuous duty rated solenoid.
- Optional coil voltages and terminations.



Curves are attained without pressure compensator. The valve can work with a pressure drop up to 200 bar.

**HYDRAULIC SYMBOL**

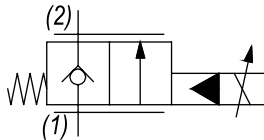

**PERFORMANCE**

**Pressure Drop**

1 to 2 with valve completely open

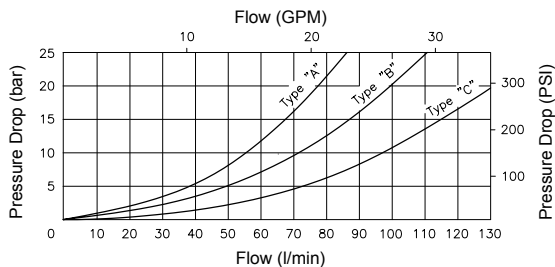

**Flow vs. Current at different Pressure Drop**

Poppet type A - Coil 12 VDC - hyd. oil 26 cSt (121 SSU) @ 40°C (104°F)

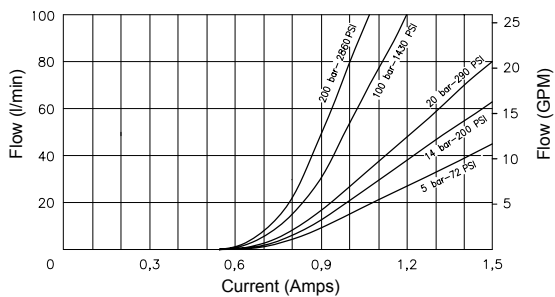

**VALVE SPECIFICATIONS**

Flow Range	See curves for various versions
Max System Pressure	3500 PSI (241 bar)
Leakage	0-10 drops / min @ 245 bar
Hysteresis	±3%
Viscosity Range	36 to 3000 SSU (3 to 647 cSt)
Filtration	ISO 18/16/13
Media Operating Temp. Range	-30°C / +100°C
Weight	.72 lbs (.32 kg)
Operating Fluid Media	General Purpose Hydraulic Fluid
Cartridge Torque Requirements	37 ft-lbs (50 Nm)
Coil Nut Torque Requirements	2-3 ft-lbs (3-4 Nm)
Cavity	TECNORD 2W
Cavity Tools Kit (form tool, reamer, tap)	40500032
Seal Kit	21191200

**COIL SPECIFICATIONS**

Current Supply Characteristics	PWM (Pulse Width Modulation)
Rated Current Range	400-1400 mA
PWM or Super-Imposed	
Dither Frequency	100 Hz
Coil Resistance (12 VDC)	7.2 Ohm ±5% at 68°F (20°C)

**WARNING:** the specifications/application data shown in our catalogs and data sheets are intended only as a general guide for the product described (herein). Any specific application should not be undertaken without independent study, evaluation, and testing for suitability.



4484 Boeing Drive Rockford, IL 61109 • USA • Phone +1 (815) 397-6628 • Fax +1 (815) 397-2526  
mail: delta@delta-power.com • www.delta-power.com



Via Malavolti, 36 • 41122 Modena • ITALY • Phone +39 (059) 254895 • Fax +39 (059) 253512  
mail: tecnord@tecnord.com • www.tecnord.com

**DIMENSIONS**

**Flow vs. Current at different Pressure Drop**

**Poppet type B** - Coil 12 VDC - hyd. oil 26 cSt (121 SSU) @ 40°C (104°F)

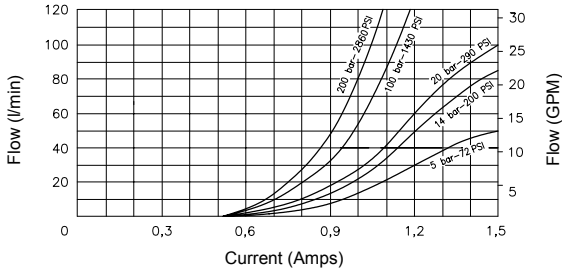

**Flow vs. Current at different Pressure Drop**

**Poppet type C** - Coil 12 VDC - hyd. oil 26 cSt (121 SSU) @ 40°C (104°F)

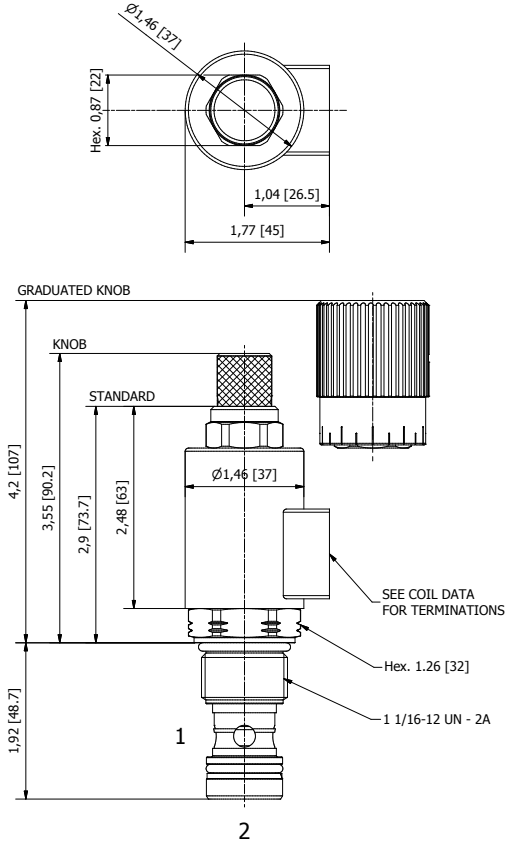
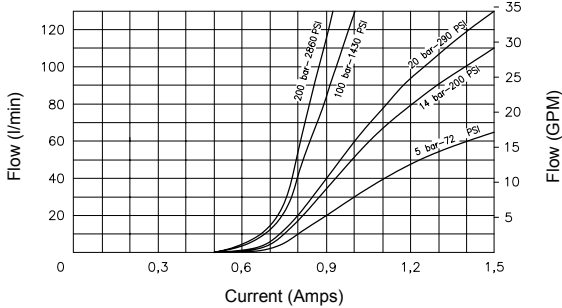

(for bodies style and sizes see section "Accessories")

**ORDERING INFORMATION**

Approximate Coil Weight: .47 lbs (.21 kg)

ET-P2A -

**OPTIONS**

- Buna Standard **A0** Up to 65 l/min
- Buna, Screw Type Override (Knob) **AS** Up to 65 l/min
- Buna, Screw Type Override (Grad. Knob) **AK** Up to 65 l/min
  
- Buna Standard **B0** Up to 85 l/min
- Buna, Screw Type Override (Knob) **BS** Up to 85 l/min
- Buna, Screw Type Override (Grad. Knob) **BK** Up to 85 l/min
  
- Buna Standard **C0** Up to 110 l/min
- Buna, Screw Type Override (Knob) **CS** Up to 110 l/min
- Buna, Screw Type Override (Grad. Knob) **CK** Up to 110 l/min

**BODIES**

- Blank** Without Body
- N** 3/4" BSP Ports
- S** #8 SAE Ports

**VOLTAGE**

- 12** 12 VDC
- 24** 24 VDC

**"F" COIL TERMINATION**

- HC** DIN 43650 (Hirschmann)
- DI** Deutsch-Integral DT04-2P
- JT** AMP Jr. Timer

**NOTES:** 1) Flows refer to a 14 bar Delta P  
2) For other seals, consult factory

**WARNING:** the specifications/application data shown in our catalogs and data sheets are intended only as a general guide for the product described (herein). Any specific application should not be undertaken without independent study, evaluation, and testing for suitability.



4484 Boeing Drive Rockford, IL 61109 • USA • Phone +1 (815) 397-6628 • Fax +1 (815) 397-2526  
mail: delta@delta-power.com • www.delta-power.com



Via Malavolti, 36 • 41122 Modena • ITALY • Phone +39 (059) 254895 • Fax +39 (059) 253512  
mail: tecnord@tecnord.com • www.tecnord.com

**WARNING:** *the specifications/application data shown in our catalogs and data sheets are intended only as a general guide for the product described (herein). Any specific application should not be undertaken without independent study, evaluation, and testing for suitability.*



4484 Boeing Drive Rockford, IL 61109 • USA • Phone +1 (815) 397-6628 • Fax +1 (815) 397-2526  
mail: [delta@delta-power.com](mailto:delta@delta-power.com) • [www.delta-power.com](http://www.delta-power.com)



Via Malavolti, 36 • 41122 Modena • ITALY • Phone +39 (059) 254895 • Fax +39 (059) 253512  
mail: [tecnord@tecnord.com](mailto:tecnord@tecnord.com) • [www.tecnord.com](http://www.tecnord.com)

**2 WAY NORMALLY OPEN PROPORTIONAL FLOW CONTROL VALVES**

SPOOL TYPE	GPM	PSI	LPM	BAR	CAVITY	MODEL	PAGE
	8	3500	30	241	7/8-14	EE-P2H	PT38

W 5 / 2018

**WARNING:** the specifications/application data shown in our catalogs and data sheets are intended only as a general guide for the product described (herein). Any specific application should not be undertaken without independent study, evaluation, and testing for suitability.



4484 Boeing Drive Rockford, IL 61109 • USA • Phone +1 (815) 397-6628 • Fax +1 (815) 397-2526  
 mail: delta@delta-power.com • [www.delta-power.com](http://www.delta-power.com)



Via Malavolti, 36 • 41122 Modena • ITALY • Phone +39 (059) 254895 • Fax +39 (059) 253512  
 mail: tecnord@tecnord.com • [www.tecnord.com](http://www.tecnord.com)

**EE-P2H 2 WAY NORMALLY OPEN, PROPORTIONAL FLOW CONTROL VALVE**

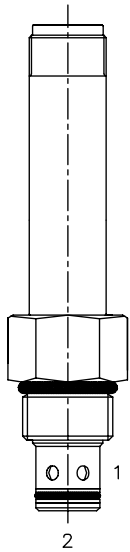

**DESCRIPTION**

10 size, 7/8-14 thread, solenoid operated, 2 way normally open, proportional flow control valve.

**OPERATION**

When de-energized the EE-P2H allows flow from (1) to (2). When fully energized, the valve blocks flow at port (1) and (2). Flow is proportional to current applied to the coil. A compensator must be used to create a pressure compensated flow control function.

**OPERATION OF MANUAL OVERRIDE OPTION:** to override, turn the manual override screw clockwise. To release turn the manual override screw counterclockwise.

**FEATURES**

- Efficient wet-armature construction.
- Cartridges are voltage interchangeable.
- Industry common cavity.
- Unitized, molded coil design.
- Continuous duty rated solenoid.
- Optional coil voltages and terminations.



Curve is attained with Tecnord QC-CP3 compensator at with various settings.

**HYDRAULIC SYMBOL**

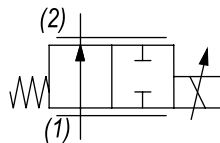

**PERFORMANCE**

**Flow (l/min) vs. Current (mA)**

Coil 12 VDC - Delta P = 5, 14, 20 bar; Toil = 40°C

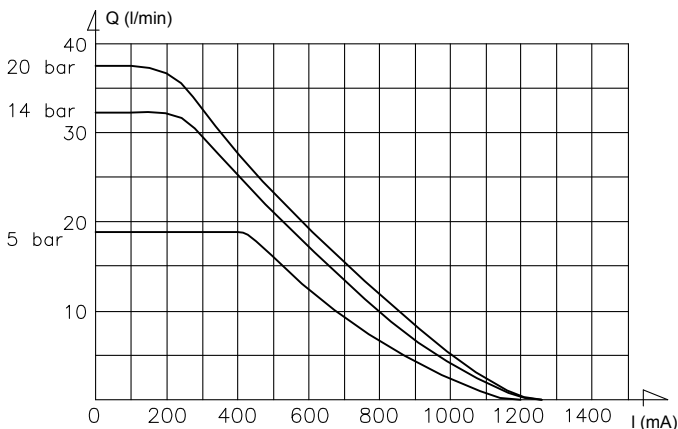

**VALVE SPECIFICATIONS**

Flow Range	See curve
Max System Pressure	3500 PSI (241 bar)
Leakage	Max 100 cc/min at 245 bar
Hysteresis	±4%
Viscosity Range	36 to 3000 SSU (3 to 647 cSt)
Filtration	ISO 18/16/13
Media Operating Temp. Range	-30°C / +100°C
Weight	.58 lbs (.26 kg)
Operating Fluid Media	General Purpose Hydraulic Fluid
Cartridge Torque Requirements	26 ft-lbs (35 Nm)
Coil Nut Torque Requirements	2-3 ft-lbs (3-4 Nm)
Cavity	DELTA 2W
Cavity Tools Kit (form tool, reamer, tap)	40500000
Seal Kit	21191200

**COIL SPECIFICATIONS**

Current Supply Characteristics	PWM (Pulse Width Modulation)
Rated Current Range	400-1400 mA
PWM or Super-Imposed	
Dither Frequency	100-150 Hz
Coil Resistance (12 VDC)	7.2 Ohm ±5% at 68°F (20°C)

**WARNING:** the specifications/application data shown in our catalogs and data sheets are intended only as a general guide for the product described (herein). Any specific application should not be undertaken without independent study, evaluation, and testing for suitability.



4484 Boeing Drive Rockford, IL 61109 • USA • Phone +1 (815) 397-6628 • Fax +1 (815) 397-2526  
 mail: delta@delta-power.com • www.delta-power.com



Via Malavolti, 36 • 41122 Modena • ITALY • Phone +39 (059) 254895 • Fax +39 (059) 253512  
 mail: tecnord@tecnord.com • www.tecnord.com

**DIMENSIONS**

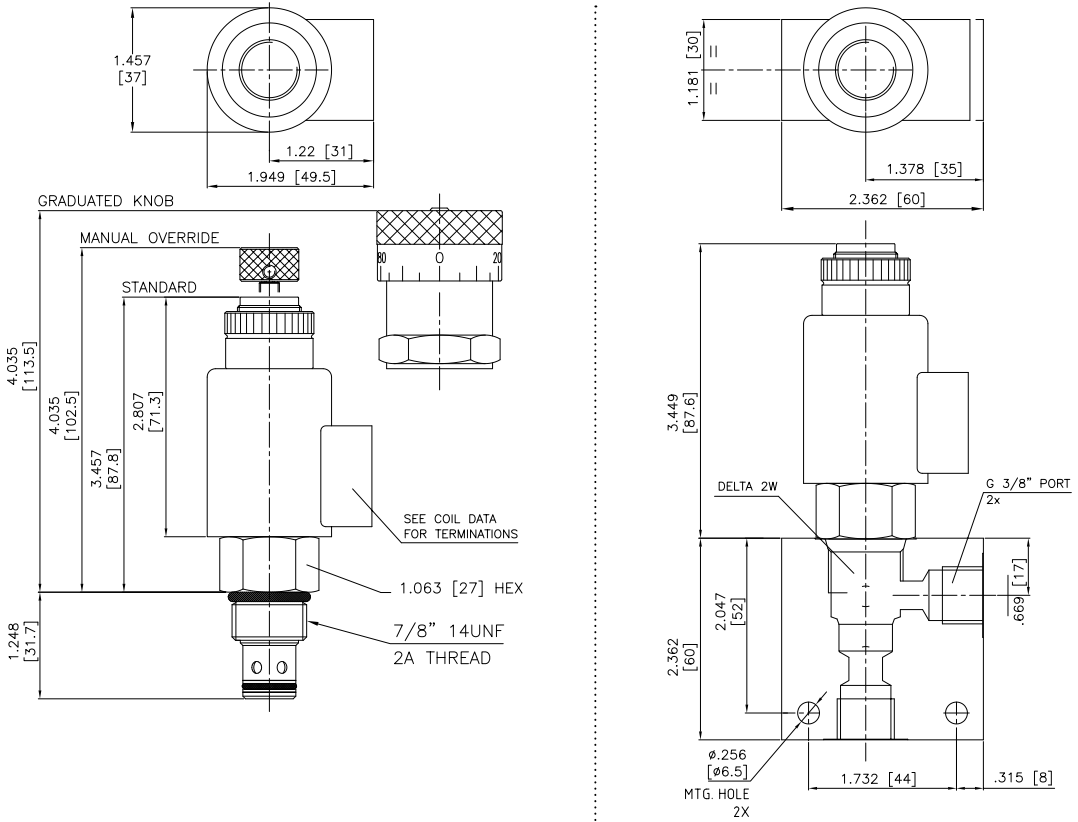

(for bodies style and sizes see section "Accessories")

**ORDERING INFORMATION**

Approximate Coil Weight: .47 lbs (.21 kg)

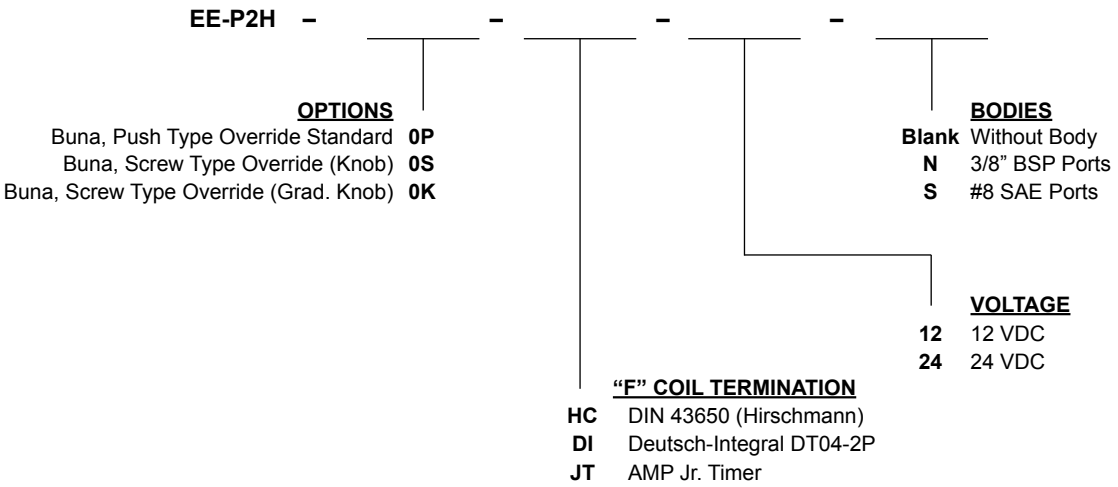

**NOTE:** for other seals, consult factory.

**WARNING:** the specifications/application data shown in our catalogs and data sheets are intended only as a general guide for the product described (herein). Any specific application should not be undertaken without independent study, evaluation, and testing for suitability.



4484 Boeing Drive Rockford, IL 61109 • USA • Phone +1 (815) 397-6628 • Fax +1 (815) 397-2526  
 mail: delta@delta-power.com • www.delta-power.com



Via Malavolti, 36 • 41122 Modena • ITALY • Phone +39 (059) 254895 • Fax +39 (059) 253512  
 mail: tecnord@tecnord.com • www.tecnord.com

**WARNING:** *the specifications/application data shown in our catalogs and data sheets are intended only as a general guide for the product described (herein). Any specific application should not be undertaken without independent study, evaluation, and testing for suitability.*



4484 Boeing Drive Rockford, IL 61109 • USA • Phone +1 (815) 397-6628 • Fax +1 (815) 397-2526  
mail: [delta@delta-power.com](mailto:delta@delta-power.com) • [www.delta-power.com](http://www.delta-power.com)



Via Malavolti, 36 • 41122 Modena • ITALY • Phone +39 (059) 254895 • Fax +39 (059) 253512  
mail: [tecnord@tecnord.com](mailto:tecnord@tecnord.com) • [www.tecnord.com](http://www.tecnord.com)



**2 WAY NORMALLY CLOSED PRESSURE COMPENSATED PROPORTIONAL FLOW REGULATOR VALVES**

POPPET TYPE	GPM	PSI	LPM	BAR	CAVITY	MODEL	PAGE
	12	3500	45	241	7/8-14	<b>EG-F2A</b>	PT42
	26	3500	100	241	1/16-12	<b>EU-F2A</b>	PT44

W 5 / 2018

**WARNING:** the specifications/application data shown in our catalogs and data sheets are intended only as a general guide for the product described (herein). Any specific application should not be undertaken without independent study, evaluation, and testing for suitability.



4484 Boeing Drive Rockford, IL 61109 • USA • Phone +1 (815) 397-6628 • Fax +1 (815) 397-2526  
 mail: delta@delta-power.com • [www.delta-power.com](http://www.delta-power.com)



Via Malavolti, 36 • 41122 Modena • ITALY • Phone +39 (059) 254895 • Fax +39 (059) 253512  
 mail: tecnord@tecnord.com • [www.tecnord.com](http://www.tecnord.com)

**EG-F2A 2 WAY PRESSURE COMPENSATED PROPORTIONAL FLOW REGULATOR**

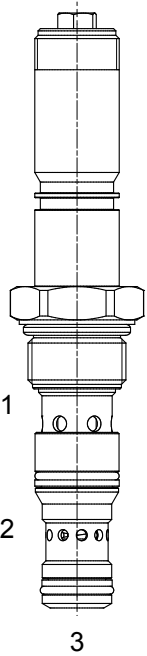

**DESCRIPTION**

10 size, 7/8-14 thread, "Delta" series, solenoid operated, normally closed, poppet style, restrictive type 2 ways pressure compensated proportional flow regulator.

**OPERATION**

EG-F2A maintains a constant flow rate out of (2) regardless of load pressure variations in the circuit downstream of (1). When coil is not energized, there is no regulated flow out of (2). The valve begins to respond to load variations when the flow through the valve creates a pressure differential across the control spool.

Reverse flow from (2) to (1) returns through the control spool and is not compensated.

**OPERATION OF MANUAL OVERRIDE OPTION:** to override, turn the manual override screw counterclockwise. To release turn the manual override screw clockwise.

**FEATURES**

- Hardened parts for long-life.
- Industry common cavity.
- Excellent linearity and low hysteresis characteristics.
- Cartridges are voltage interchangeable.
- Optional coil voltages and terminations available.
- Unitized, molded coil design.
- Continuous duty rated solenoid.



Port (1) must be connected in the manifold to port (3).

**HYDRAULIC SYMBOL**

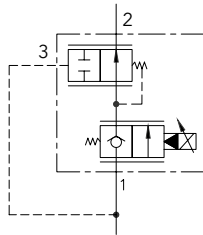

**PERFORMANCE**

Flow (l/min) vs. Current (mA - PWM @ 100 Hz)

14 bar Compensated

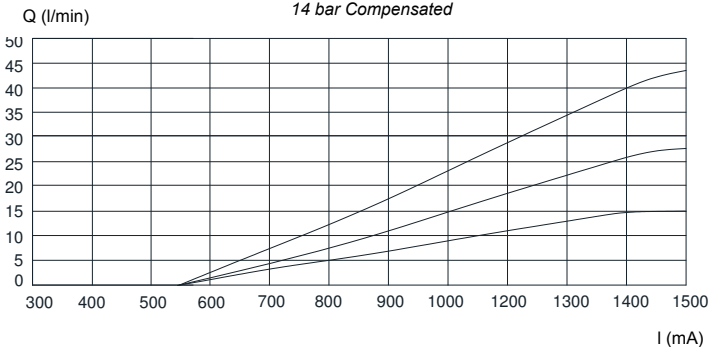

**VALVE SPECIFICATIONS**

Flow Range	See curves for various versions
Max System Pressure	3500 PSI (241 bar)
Leakage	0-10 drops / min @ 245 bar
Hysteresis	±5%
Viscosity Range	36 to 3000 SSU (3 to 647 cSt)
Filtration	ISO 18/16/13
Media Operating Temp. Range	-30°C / +100°C
Operating Fluid Media	General Purpose Hydraulic Fluid
Cartridge Torque Requirements	30 ft-lbs (41 Nm)
Coil Nut Torque Requirements	2-3 ft-lbs (3-4 Nm)
Cavity	T308
Cavity Tools Kit (form tool, reamer, tap)	K-T308

**COIL SPECIFICATIONS**

Current Supply Characteristics	PWM (Pulse Width Modulation)
Rated Current Range	400-1400 mA
PWM or Super-Imposed	
Dither Frequency	100 Hz
Coil Resistance (12 VDC)	7.2 Ohm ±5% at 68°F (20°C)

**WARNING:** the specifications/application data shown in our catalogs and data sheets are intended only as a general guide for the product described (herein). Any specific application should not be undertaken without independent study, evaluation, and testing for suitability.



4484 Boeing Drive Rockford, IL 61109 • USA • Phone +1 (815) 397-6628 • Fax +1 (815) 397-2526  
 mail: delta@delta-power.com • www.delta-power.com



Via Malavolti, 36 • 41122 Modena • ITALY • Phone +39 (059) 254895 • Fax +39 (059) 253512  
 mail: tecnord@tecnord.com • www.tecnord.com

**DIMENSIONS**

**Regulated Flow vs. Pressure**

Coil 12 VDC - 130 Hz PWM - Oil 26 cSt (121 SSU) @ 50°C (104°F)

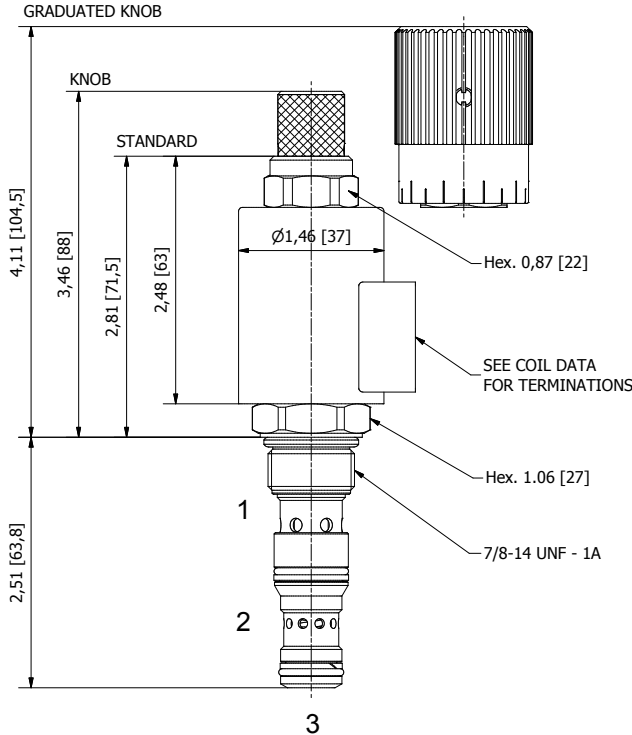
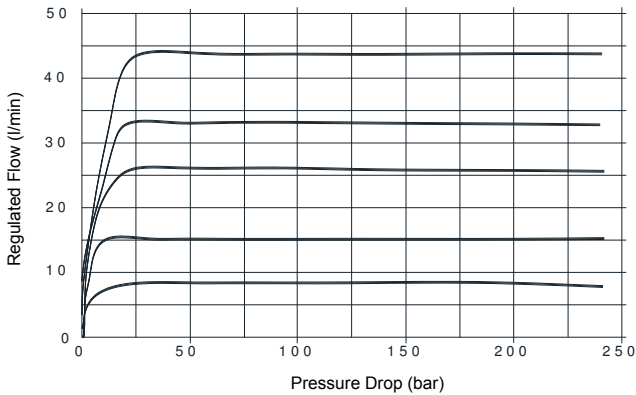

(for bodies style and sizes see section "Accessories")

**ORDERING INFORMATION**

Approximate Coil Weight: .47 lbs (.21 kg)

**EG-F2A - - - -**

**OPTIONS**

- Buna Standard **A0** Up to 15 l/min
- Buna, Screw Type Override (Knob) **AS** Up to 15 l/min
- Buna, Screw Type Override (Grad. Knob) **AK** Up to 15 l/min
  
- Buna Standard **B0** Up to 30 l/min
- Buna, Screw Type Override (Knob) **BS** Up to 30 l/min
- Buna, Screw Type Override (Grad. Knob) **BK** Up to 30 l/min
  
- Buna Standard **C0** Up to 45 l/min
- Buna, Screw Type Override (Knob) **CS** Up to 45 l/min
- Buna, Screw Type Override (Grad. Knob) **CK** Up to 45 l/min

**BODIES**

- Blank** Without Body
- N** 3/8" BSP Ports
- S** #6 SAE Ports

**VOLTAGE**

- 12** 12 VDC
- 24** 24 VDC

**"F" COIL TERMINATION**

- HC** DIN 43650 (Hirschmann)
- DI** Deutsch-Integral DT04-2P
- JT** AMP Jr. Timer

**NOTE:** for other seals, consult factory.

W 5 / 2018

**WARNING:** the specifications/application data shown in our catalogs and data sheets are intended only as a general guide for the product described (herein). Any specific application should not be undertaken without independent study, evaluation, and testing for suitability.



4484 Boeing Drive Rockford, IL 61109 • USA • Phone +1 (815) 397-6628 • Fax +1 (815) 397-2526  
 mail: delta@delta-power.com • www.delta-power.com



Via Malavolti, 36 • 41122 Modena • ITALY • Phone +39 (059) 254895 • Fax +39 (059) 253512  
 mail: tecnord@tecnord.com • www.tecnord.com

**EU-F2A 2 WAY PRESSURE COMPENSATED PROPORTIONAL FLOW REGULATOR**

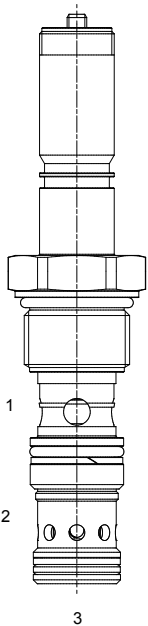

**DESCRIPTION**

12 size, 1" 1/16-12 thread, "Tecnord" series, solenoid operated, normally closed, poppet style, restrictive type 2 ways pressure compensated proportional flow regulator.

**OPERATION**

EU-F2A maintains a constant flow rate out of (2) regardless of load pressure variations in the circuit downstream of (1). When coil is not energized, there is no regulated flow out of (2). The valve begins to respond to load variations when the flow through the valve creates a pressure differential across the control spool.

Reverse flow from (2) to (1) returns through the control spool and is not compensated. The manual override increases flow by counter-clockwise rotation of the manual override knob.

**FEATURES**

- Hardened parts for long-life.
- Industry common cavity.
- Excellent linearity and low hysteresis characteristics.
- Cartridges are voltage interchangeable.
- Optional coil voltages and terminations available.
- Unitized, molded coil design.
- Continuous duty rated solenoid.



Port (1) must be connected in the manifold to port (3).

**HYDRAULIC SYMBOL**

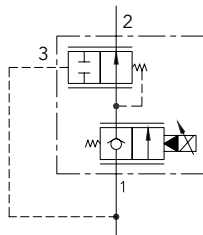

**PERFORMANCE**

**Regulated Flow vs. Pressure**

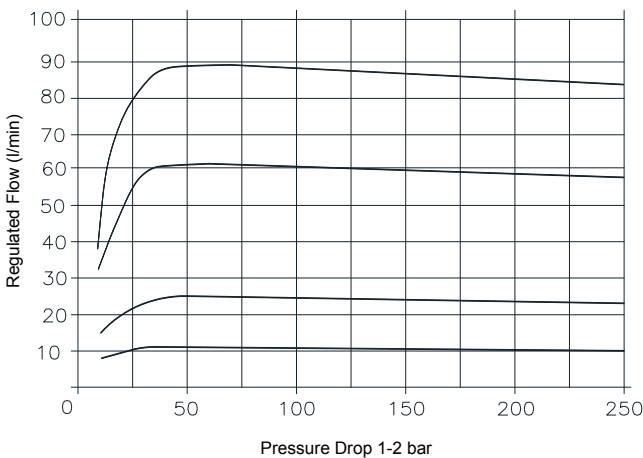

**VALVE SPECIFICATIONS**

Flow Range	See curves for various versions
Max System Pressure	3500 PSI (241 bar)
Leakage	0-10 drops / min @ 245 bar
Hysteresis	±5%
Viscosity Range	36 to 3000 SSU (3 to 647 cSt)
Filtration	ISO 18/16/13
Media Operating Temp. Range	-30°C / +100°C
Weight	.72 lbs (.32 kg)
Operating Fluid Media	General Purpose Hydraulic Fluid
Cartridge Torque Requirements	37 ft-lbs (50 Nm)
Coil Nut Torque Requirements	2-3 ft-lbs (3-4 Nm)
Cavity	TECNORD 3W
Cavity Tools Kit (form tool, reamer, tap)	40500034

**COIL SPECIFICATIONS**

Current Supply Characteristics	PWM (Pulse Width Modulation)
Rated Current Range	500-1400 mA
PWM or Super-Imposed	
Dither Frequency	100 Hz
Coil Resistance (12 VDC)	7.2 Ohm ±5% at 68°F (20°C)

**WARNING:** the specifications/application data shown in our catalogs and data sheets are intended only as a general guide for the product described (herein). Any specific application should not be undertaken without independent study, evaluation, and testing for suitability.



4484 Boeing Drive Rockford, IL 61109 • USA • Phone +1 (815) 397-6628 • Fax +1 (815) 397-2526  
mail: delta@delta-power.com • www.delta-power.com



Via Malavolti, 36 • 41122 Modena • ITALY • Phone +39 (059) 254895 • Fax +39 (059) 253512  
mail: tecnord@tecnord.com • www.tecnord.com

**DIMENSIONS**

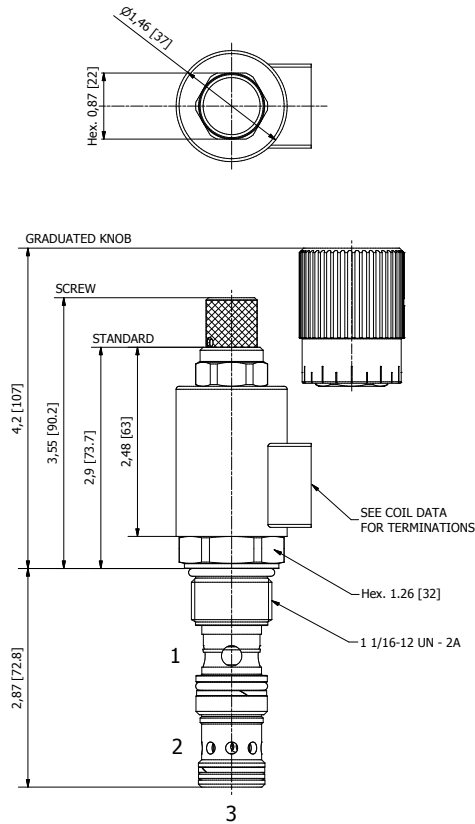
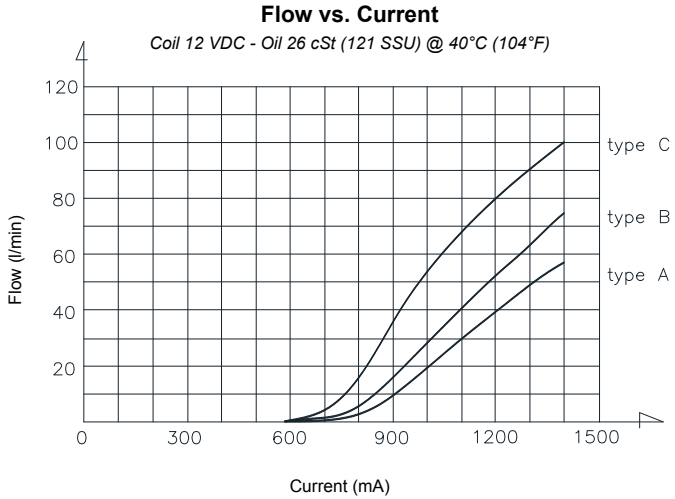

(for bodies style and sizes see section "Accessories")

**ORDERING INFORMATION**

Approximate Coil Weight: .47 lbs (.21 kg)

EU-F2A - - - -

**OPTIONS**

- Buna Standard **A0** Up to 55 l/min
- Buna, Screw Type Override (Knob) **AS** Up to 55 l/min
- Buna, Screw Type Override (Grad. Knob) **AK** Up to 55 l/min
  
- Buna Standard **B0** Up to 75 l/min
- Buna, Screw Type Override (Knob) **BS** Up to 75 l/min
- Buna, Screw Type Override (Grad. Knob) **BK** Up to 75 l/min
  
- Buna Standard **C0** Up to 100 l/min
- Buna, Screw Type Override (Knob) **CS** Up to 100 l/min
- Buna, Screw Type Override (Grad. Knob) **CK** Up to 100 l/min

**BODIES**

- Blank** Without Body
- N** 3/4" BSP Ports
- S** #8 SAE Ports

**VOLTAGE**

- 12** 12 VDC
- 24** 24 VDC

**"F" COIL TERMINATION**

- HC** DIN 43650 (Hirschmann)
- DI** Deutsch-Integral DT04-2P
- JT** AMP Jr. Timer

**NOTE:** for other seals, consult factory.

**WARNING:** the specifications/application data shown in our catalogs and data sheets are intended only as a general guide for the product described (herein). Any specific application should not be undertaken without independent study, evaluation, and testing for suitability.



4484 Boeing Drive Rockford, IL 61109 • USA • Phone +1 (815) 397-6628 • Fax +1 (815) 397-2526  
 mail: delta@delta-power.com • www.delta-power.com



Via Malavolti, 36 • 41122 Modena • ITALY • Phone +39 (059) 254895 • Fax +39 (059) 253512  
 mail: tecnord@tecnord.com • www.tecnord.com

**WARNING:** *the specifications/application data shown in our catalogs and data sheets are intended only as a general guide for the product described (herein). Any specific application should not be undertaken without independent study, evaluation, and testing for suitability.*



4484 Boeing Drive Rockford, IL 61109 • USA • Phone +1 (815) 397-6628 • Fax +1 (815) 397-2526  
mail: [delta@delta-power.com](mailto:delta@delta-power.com) • [www.delta-power.com](http://www.delta-power.com)



Via Malavolti, 36 • 41122 Modena • ITALY • Phone +39 (059) 254895 • Fax +39 (059) 253512  
mail: [tecnord@tecnord.com](mailto:tecnord@tecnord.com) • [www.tecnord.com](http://www.tecnord.com)

**3 WAY NORMALLY CLOSED PRESSURE COMPENSATED PROPORTIONAL FLOW REGULATOR VALVES**

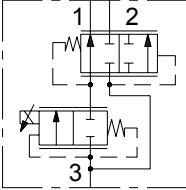
SPOOL TYPE	GPM	PSI	LPM	BAR	CAVITY	MODEL	PAGE
	6	3500	23	241	7/8-14	<b>EF-F3G</b>	PT48
	16	3500	60	241	1/16-12	<b>EU-F3G</b>	PT50

W 5 / 2018

**WARNING:** the specifications/application data shown in our catalogs and data sheets are intended only as a general guide for the product described (herein). Any specific application should not be undertaken without independent study, evaluation, and testing for suitability.



4484 Boeing Drive Rockford, IL 61109 • USA • Phone +1 (815) 397-6628 • Fax +1 (815) 397-2526  
 mail: delta@delta-power.com • [www.delta-power.com](http://www.delta-power.com)



Via Malavolti, 36 • 41122 Modena • ITALY • Phone +39 (059) 254895 • Fax +39 (059) 253512  
 mail: tecnord@tecnord.com • [www.tecnord.com](http://www.tecnord.com)

**EF-F3G 3 WAY PRESSURE COMPENSATED PRIORITY TYPE PROP. FLOW REGULATOR**

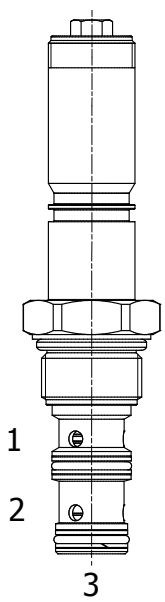

**DESCRIPTION**

10 size, 7/8-14 thread, "Delta" series, solenoid operated, normally closed, spool style, 3 ways priority type pressure compensated proportional flow regulator. It can also be used as a restrictive-type 2 way, pressure-compensated flow regulator when the bypass line (port 2) is blocked.

**OPERATION**

EF-F3G maintains a constant flow rate out of (1) regardless of load pressure variations in the circuit downstream of (3) and regardless bypass pressure variations in the circuit downstream of (2). Excess flow bypasses out of (2). When coil is not energized, there is no regulated flow out of (1).

**OPERATION OF MANUAL OVERRIDE OPTION:** to override, turn the manual override screw counterclockwise. To release turn the manual override screw clockwise.

**FEATURES**

- Hardened parts for long-life.
- Industry common cavity.
- Excellent linearity and low hysteresis characteristics.
- Cartridges are voltage interchangeable.
- Optional coil voltages and terminations available.
- Unitized, molded coil design.
- Continuous duty rated solenoid.



*It can be used as a restrictive 2-way pressure-compensated flow control valve, blocking bypass line port (2).*

**HYDRAULIC SYMBOL**

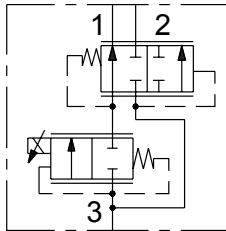

**PERFORMANCE**

**Flow vs. Current**

Coil 12 VDC - 130 Hz PWM - Oil 26 cSt (121 SSU) @ 50°C (104°F)

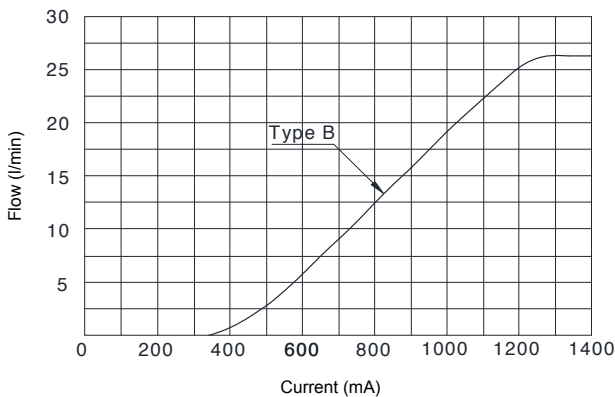

**VALVE SPECIFICATIONS**

Flow Range	See curves for various versions
Max System Pressure	3500 PSI (241 bar)
Leakage	10 cu-in/min @ 3000 PSI 160 cc/min @ 207 bar
Hysteresis	±5%
Viscosity Range	36 to 3000 SSU (3 to 647 cSt)
Filtration	ISO 18/16/13
Media Operating Temp. Range	-30°C / +100°C
Weight	.49 lbs (.22 kg)
Operating Fluid Media	General Purpose Hydraulic Fluid
Cartridge Torque Requirements	30 ft-lbs (41 Nm)
Coil Nut Torque Requirements	2-3 ft-lbs (3-4 Nm)
Cavity	DELTA 3W
Cavity Tools Kit (form tool, reamer, tap)	40500001

**COIL SPECIFICATIONS**

Current Supply Characteristics	PWM (Pulse Width Modulation)
Rated Current Range	400-1400 mA
PWM or Super-Imposed	
Dither Frequency	120-140 Hz
Coil Resistance (12 VDC)	7.2 Ohm ±5% at 68°F (20°C)

**WARNING:** the specifications/application data shown in our catalogs and data sheets are intended only as a general guide for the product described (herein). Any specific application should not be undertaken without independent study, evaluation, and testing for suitability.



4484 Boeing Drive Rockford, IL 61109 • USA • Phone +1 (815) 397-6628 • Fax +1 (815) 397-2526  
mail: delta@delta-power.com • www.delta-power.com



Via Malavolti, 36 • 41122 Modena • ITALY • Phone +39 (059) 254895 • Fax +39 (059) 253512  
mail: tecnord@tecnord.com • www.tecnord.com



**DIMENSIONS**

**Pressure Drop 3→2 (bar)**

Oil 26 cSt (121 SSU) @ 50°C (104°F)

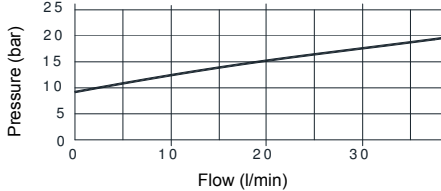

**Regulated Flow vs. Pressure**

2 WAYS - Coil 12 VDC - 130 Hz PWM - Oil 26 cSt (121 SSU) @ 50°C (104°F)

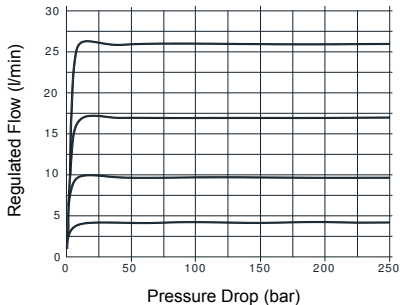

**Pres. Compensation from Inlet to Work Port or Bypass Port**

3 WAYS - Coil 12 VDC - 130 Hz PWM - Oil 26 cSt (121 SSU) @ 50°C (104°F)

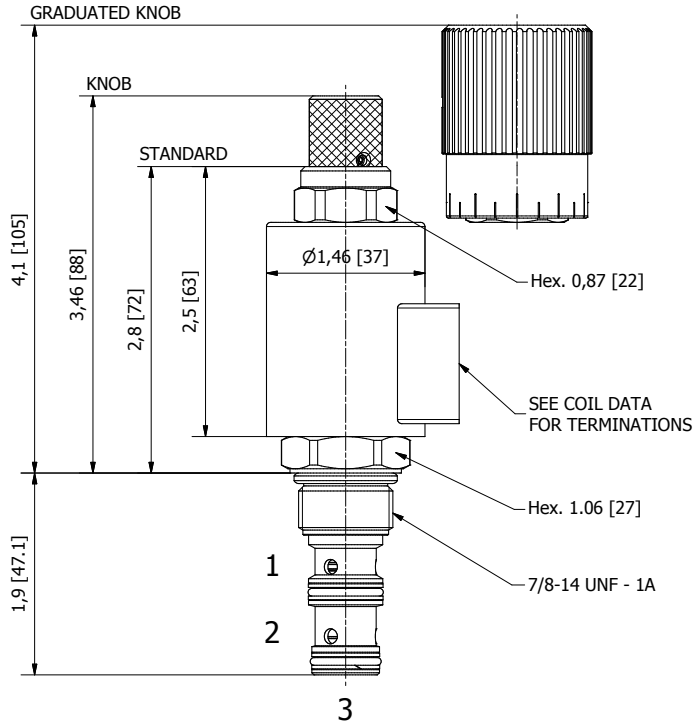
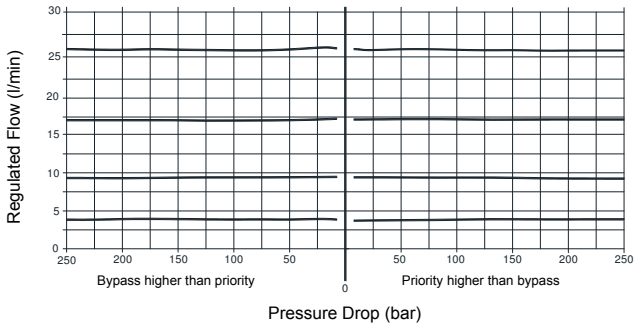

(for bodies style and sizes see section "Accessories")

**ORDERING INFORMATION**

Approximate Coil Weight: .47 lbs (.21 kg)

EF-F3G

- OPTIONS**
- Buna Standard **B0** Up to 25 l/min
  - Buna, Screw Type Override (Knob) **BS** Up to 25 l/min
  - Buna, Screw Type Override (Grad. Knob) **BK** Up to 25 l/min

- BODIES**
- Blank Without Body
  - N** 3/8" BSP Ports
  - S** #6 SAE Ports

**"F" COIL TERMINATION**

- |                                    |                  |
|------------------------------------|------------------|
| <b>HC</b> DIN 43650 (Hirschmann)   | <b>12</b> 12 VDC |
| <b>DI</b> Deutsch-Integral DT04-2P | <b>24</b> 24 VDC |
| <b>JT</b> AMP Jr. Timer            |                  |

**VOLTAGE**

**NOTES:** 1) For other flow settings, consult factory.  
2) For other seals, consult factory.

W 5 / 2018

**WARNING:** the specifications/application data shown in our catalogs and data sheets are intended only as a general guide for the product described (herein). Any specific application should not be undertaken without independent study, evaluation, and testing for suitability.



4484 Boeing Drive Rockford, IL 61109 • USA • Phone +1 (815) 397-6628 • Fax +1 (815) 397-2526  
mail: delta@delta-power.com • www.delta-power.com



Via Malavolti, 36 • 41122 Modena • ITALY • Phone +39 (059) 254895 • Fax +39 (059) 253512  
mail: tecnord@tecnord.com • www.tecnord.com

**EU-F3G 3 WAY PRESSURE COMPENSATED PRIORITY TYPE PROPORTIONAL FLOW REGULATOR**

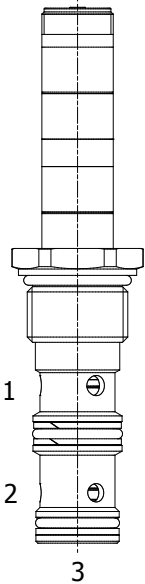

**DESCRIPTION**

12 size, 1" 1/16-12 thread, "Tecnom" series, solenoid operated, normally closed, spool style, 3 ways priority type pressure compensated proportional flow regulator. It can also be used as a restrictive-type 2 way, pressure-compensated flow regulator when the bypass line (port 2) is blocked.

**OPERATION**

EU-F3G maintains a constant flow rate out of (1) regardless of load pressure variations in the circuit downstream of (3) and regardless bypass pressure variations in the circuit downstream of (2). Excess flow bypasses out of (2). When coil is not energized, there is no regulated flow out of (1).

**OPERATION OF MANUAL OVERRIDE OPTION:** to override, turn the manual override screw counterclockwise. To release turn the manual override screw clockwise.

**FEATURES**

- Hardened parts for long-life.
- Industry common cavity.
- Excellent linearity and low hysteresis characteristics.
- Cartridges are voltage interchangeable.
- Optional coil voltages and terminations available.
- Unitized, molded coil design.
- Continuous duty rated solenoid.



*It can be used as a restrictive 2-way pressure-compensated flow control valve, blocking bypass line port (2).*

**HYDRAULIC SYMBOL**

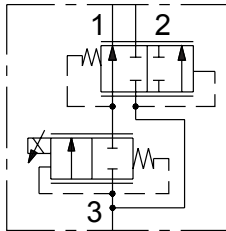

**PERFORMANCE**

**Flow vs. Current**

Coil 12 VDC - 130 Hz PWM - Oil 26 cSt (121 SSU) @ 50°C (104°F)

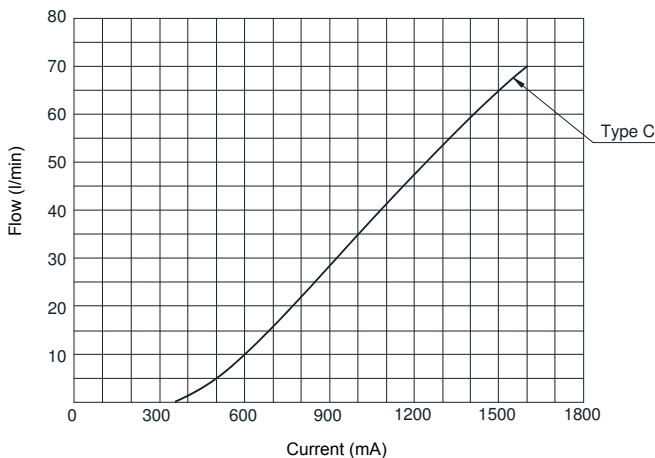

**VALVE SPECIFICATIONS**

Flow Range	See curves for various versions
Max System Pressure	3500 PSI (241 bar)
Leakage	15.7 cu-in/min @ 3000 PSI 250 cc/min @ 207 bar
Hysteresis	±5%
Viscosity Range	36 to 3000 SSU (3 to 647 cSt)
Filtration	ISO 18/16/13
Media Operating Temp. Range	-30°C / +100°C
Weight	.75 lbs (.34 kg)
Operating Fluid Media	General Purpose Hydraulic Fluid
Cartridge Torque Requirements	37 ft-lbs (50 Nm)
Coil Nut Torque Requirements	2-3 ft-lbs (3-4 Nm)
Cavity	TECNORD 3W
Cavity Tools Kit (form tool, reamer, tap)	40500034

**COIL SPECIFICATIONS**

Current Supply Characteristics	PWM (Pulse Width Modulation)
Rated Current Range	400-1400 mA
PWM or Super-Imposed	
Dither Frequency	120-140 Hz
Coil Resistance (12 VDC)	7.2 Ohm ±5% at 68°F (20°C)

**WARNING:** the specifications/application data shown in our catalogs and data sheets are intended only as a general guide for the product described (herein). Any specific application should not be undertaken without independent study, evaluation, and testing for suitability.



4484 Boeing Drive Rockford, IL 61109 • USA • Phone +1 (815) 397-6628 • Fax +1 (815) 397-2526  
mail: delta@delta-power.com • www.delta-power.com



Via Malavolti, 36 • 41122 Modena • ITALY • Phone +39 (059) 254895 • Fax +39 (059) 253512  
mail: tecnord@tecnord.com • www.tecnord.com

**DIMENSIONS**

**Pressure Drop 3→2 (bar)**

Oil 26 cSt (121 SSU) @ 50°C (104°F)

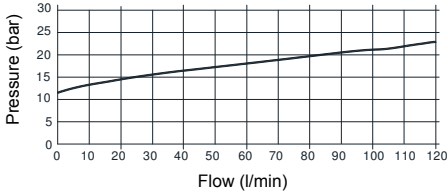

**Regulated Flow vs. Pressure**

2 WAYS - Coil 12 VDC - 130 Hz PWM - Oil 26 cSt (121 SSU) @ 50°C (104°F)

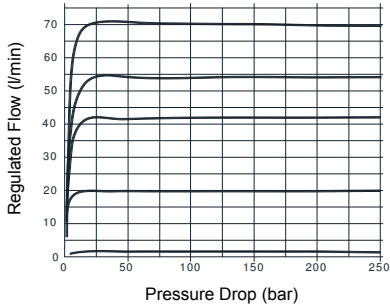

**Pres. Compensation from Inlet to Work Port or Bypass Port**

3 WAYS - Coil 12 VDC - 130 Hz PWM - Oil 26 cSt (121 SSU) @ 50°C (104°F)

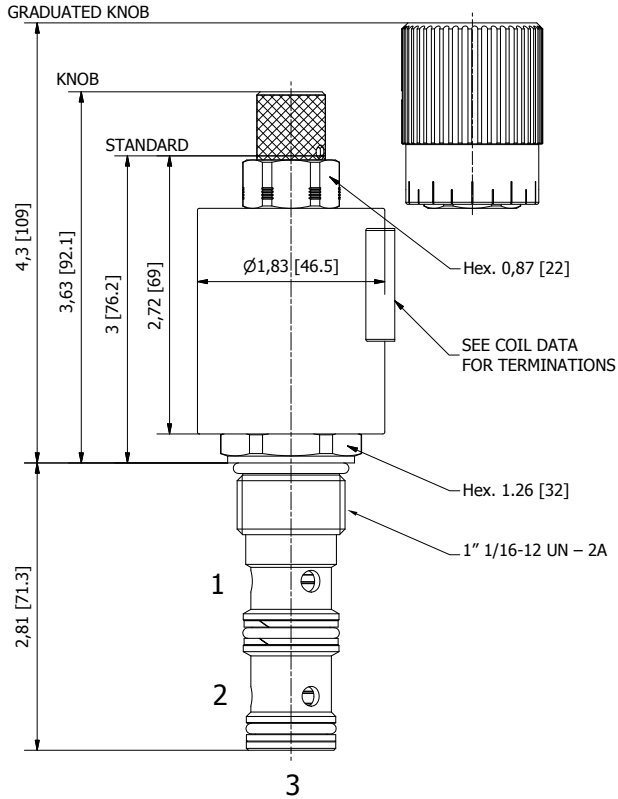
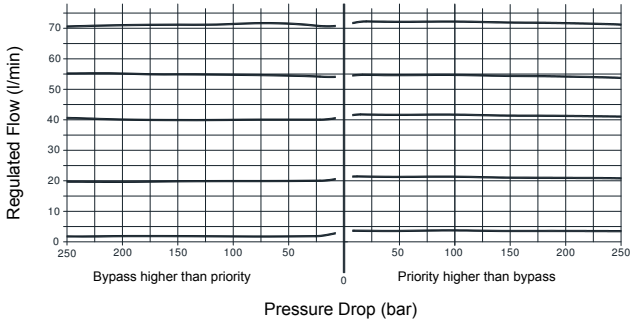

(for bodies style and sizes see section "Accessories")

**ORDERING INFORMATION**

Approximate Coil Weight: .47 lbs (.21 kg)

**EU-F3G** - - - -

**OPTIONS**

- Buna Standard **C0** Up to 60 l/min
- Buna, Screw Type Override (Knob) **CS** Up to 60 l/min
- Buna, Screw Type Override (Grad. Knob) **CK** Up to 60 l/min

**BODIES**

- Blank Without Body
- N** 3/4" BSP Ports
- S** #8 SAE Ports

**"Z" COIL TERMINATION**

- HC** DIN 43650 (Hirschmann)
- DI** Deutsch-Integral DT04-2P
- JT** AMP Jr. Timer

**VOLTAGE**

- 12** 12 VDC
- 24** 24 VDC

**NOTES:** 1) For other flow settings, consult factory.  
2) For other seals, consult factory.

W 5 / 2018

**WARNING:** the specifications/application data shown in our catalogs and data sheets are intended only as a general guide for the product described (herein). Any specific application should not be undertaken without independent study, evaluation, and testing for suitability.



4484 Boeing Drive Rockford, IL 61109 • USA • Phone +1 (815) 397-6628 • Fax +1 (815) 397-2526  
mail: delta@delta-power.com • www.delta-power.com



Via Malavolti, 36 • 41122 Modena • ITALY • Phone +39 (059) 254895 • Fax +39 (059) 253512  
mail: tecnord@tecnord.com • www.tecnord.com

**WARNING:** *the specifications/application data shown in our catalogs and data sheets are intended only as a general guide for the product described (herein). Any specific application should not be undertaken without independent study, evaluation, and testing for suitability.*



4484 Boeing Drive Rockford, IL 61109 • USA • Phone +1 (815) 397-6628 • Fax +1 (815) 397-2526  
mail: [delta@delta-power.com](mailto:delta@delta-power.com) • [www.delta-power.com](http://www.delta-power.com)



Via Malavolti, 36 • 41122 Modena • ITALY • Phone +39 (059) 254895 • Fax +39 (059) 253512  
mail: [tecnord@tecnord.com](mailto:tecnord@tecnord.com) • [www.tecnord.com](http://www.tecnord.com)

**4W/3P PROPORTIONAL DIRECTIONAL CONTROL VALVES**

MOTOR SPOOL TYPE	GPM	PSI	LPM	BAR	CAVITY	MODEL	PAGE
	3	3500	11	241	3/4-16	<b>EQ-S4M</b>	PT54
	6	3500	23	241	7/8-14	<b>EG-S4M</b>	PT56

CYLINDER SPOOL TYPE	GPM	PSI	LPM	BAR	CAVITY	MODEL	PAGE
	3	3500	11	241	3/4-16	<b>EQ-S4P</b>	PT58
	6	3500	23	241	7/8-14	<b>EG-S4P</b>	PT60

W 5 / 2018

**WARNING:** the specifications/application data shown in our catalogs and data sheets are intended only as a general guide for the product described (herein). Any specific application should not be undertaken without independent study, evaluation, and testing for suitability.



4484 Boeing Drive Rockford, IL 61109 • USA • Phone +1 (815) 397-6628 • Fax +1 (815) 397-2526  
 mail: delta@delta-power.com • [www.delta-power.com](http://www.delta-power.com)



Via Malavolti, 36 • 41122 Modena • ITALY • Phone +39 (059) 254895 • Fax +39 (059) 253512  
 mail: tecnord@tecnord.com • [www.tecnord.com](http://www.tecnord.com)

**EQ-S4M 4 WAY 3 POSITION, MOTOR SPOOL, PROPORTIONAL DIRECTIONAL VALVE**

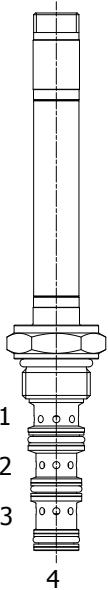

**DESCRIPTION**

8 size, 3/4-16 thread, "Power" series, solenoid operated, 4 way 3 position, Motor Spool, proportional directional valve.

**OPERATION**

EQ-S4M, when de-energized, blocks flow at (2) and allows flow between (1), (3) and (4). When coil (S1) is energized, flow is allowed from (3) to (4), and from (2) to (1). When coil (S2) is energized, flow is allowed from (3) to (2), and from (4) to (1). Flow is proportional to the current applied to the coil. A compensator must be used to create a pressure compensated flow control function.

**FEATURES**

- Hardened parts for long-life.
- Industry common cavity.
- Excellent linearity and low hysteresis characteristics.
- Cartridges are voltage interchangeable.
- Optional coil voltages and terminations available.
- Unitized, molded coil design.
- Continuous duty rated solenoid.

**HYDRAULIC SYMBOL**

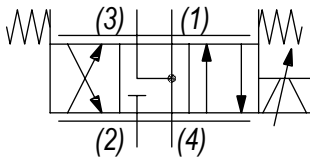

**PERFORMANCE**

**Flow vs. Current**

Coil 12VDC – 100 Hz PWM – Oil 26cSt (121 SSU) @ 50°C (122°F)  
Operating curves made with circuit having a pressure drop of 14bar

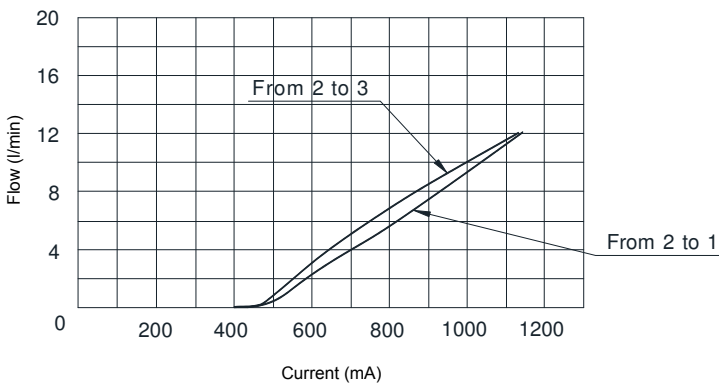

**VALVE SPECIFICATIONS**

Flow Range	See curves for various versions
Max System Pressure	3500 PSI (241 bar)
Leakage	10 cu-in/min 160 cc/min bar @ 210 bar
Hysteresis	±5%
Viscosity Range	36 to 3000 SSU (3 to 647 cSt)
Filtration	ISO 18/16/13
Media Operating Temp. Range	-30°C / +100°C
Operating Fluid Media	General Purpose Hydraulic Fluid
Cartridge Torque Requirements	18 ft-lbs (26 Nm)
Coil Nut Torque Requirements	2-3 ft-lbs (3-4 Nm)
Cavity	POWER 4W
Cavity Tools Kit (form tool, reamer, tap)	40500029

**COIL SPECIFICATIONS**

Current Supply Characteristics	PWM (Pulse Width Modulation)
Rated Current Range	400-1300 mA
PWM or Super-Imposed	
Dither Frequency	100-200 Hz
Coil Resistance (12 VDC)	6.85 Ohm ±5% at 68°F (20°C)

**WARNING:** the specifications/application data shown in our catalogs and data sheets are intended only as a general guide for the product described (herein). Any specific application should not be undertaken without independent study, evaluation, and testing for suitability.



4484 Boeing Drive Rockford, IL 61109 • USA • Phone +1 (815) 397-6628 • Fax +1 (815) 397-2526  
mail: delta@delta-power.com • www.delta-power.com



Via Malavolti, 36 • 41122 Modena • ITALY • Phone +39 (059) 254895 • Fax +39 (059) 253512  
mail: tecnord@tecnord.com • www.tecnord.com

**DIMENSIONS**

**Pressure Drop vs. Flow**

Oil 26cSt (121 SSU)@ 50°C (122°F)

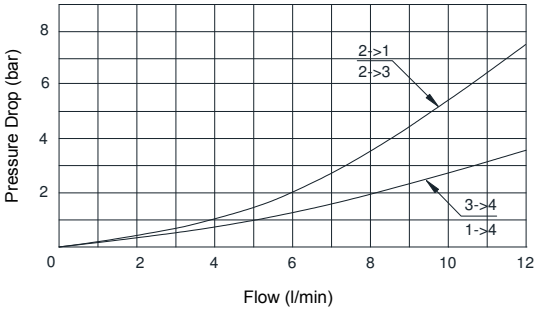

**Pressure Compensation from Inlet to Work Port**

Oil 26cSt (121 SSU)@ 50°C (122°F)

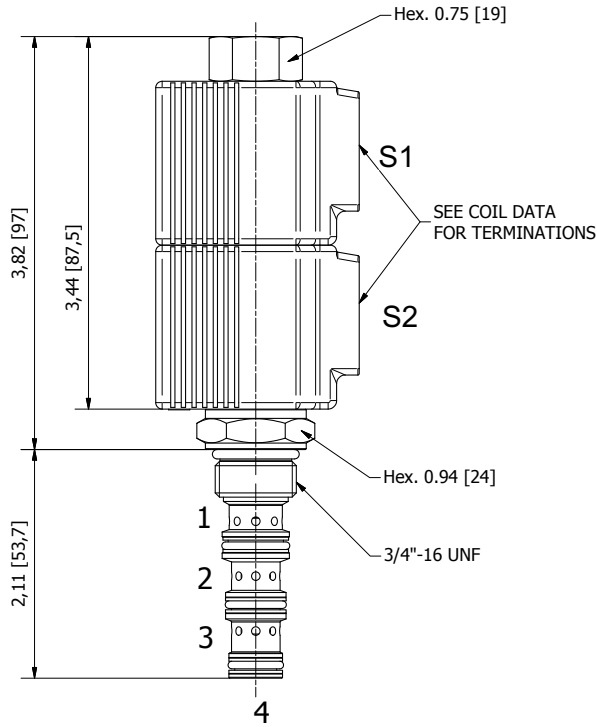
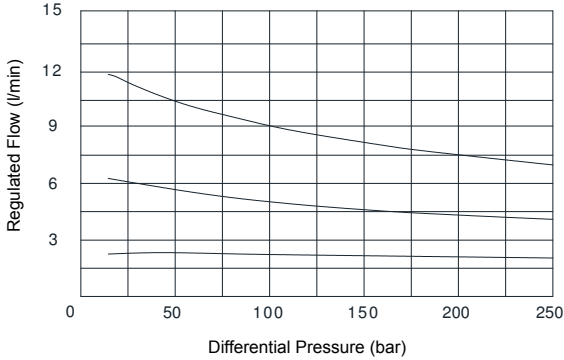

(for bodies style and sizes see section "Accessories")

**ORDERING INFORMATION**

Approximate Coil Weight: .47 lbs (.21 kg)

**EQ-S4M - - - -**

**OPTIONS**

- Buna Standard **B0** Up to 8 l/min
- Buna Standard **C0** Up to 12 l/min

**BODIES**

- Blank** Without Body
- N** 3/8" BSP Ports
- S** #6 SAE Ports

**VOLTAGE**

- 12** 12 VDC
- 24** 24 VDC

**"PJ" COIL TERMINATION**

- JH** DIN 43650 (Hirschmann)
- JD** Deutsch-Integral DT04-2P
- JA** AMP Superseal
- JJ** AMP Jr. Timer

**NOTE:** for other seals, consult factory.

W/11 /2018

**WARNING:** the specifications/application data shown in our catalogs and data sheets are intended only as a general guide for the product described (herein). Any specific application should not be undertaken without independent study, evaluation, and testing for suitability.



4484 Boeing Drive Rockford, IL 61109 • USA • Phone +1 (815) 397-6628 • Fax +1 (815) 397-2526  
 mail: delta@delta-power.com • www.delta-power.com



Via Malavolti, 36 • 41122 Modena • ITALY • Phone +39 (059) 254895 • Fax +39 (059) 253512  
 mail: tecnord@tecnord.com • www.tecnord.com

**EG-S4M 4 WAY 3 POSITION, MOTOR SPOOL, PROPORTIONAL DIRECTIONAL VALVE**

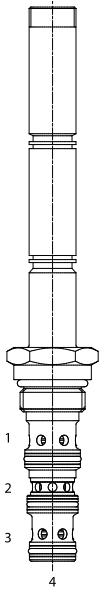

**DESCRIPTION**

10 size, 7/8-14 thread, "Delta" series, solenoid operated, 4 way 3 position, Motor Spool, proportional directional valve.

**OPERATION**

EG-S4M, when de-energized, blocks flow at (2) and allows flow between (1), (3) and (4). When coil (S1) is energized, flow is allowed from (3) to (4), and from (2) to (1). When coil (S2) is energized, flow is allowed from (3) to (2), and from (4) to (1). Flow is proportional to the current applied to the coil. A compensator must be used to create a pressure compensated flow control function.

**FEATURES**

- Hardened parts for long-life.
- Industry common cavity.
- Excellent linearity and low hysteresis characteristics.
- Cartridges are voltage interchangeable.
- Optional coil voltages and terminations available.
- Unitized, molded coil design.
- Continuous duty rated solenoid.

**HYDRAULIC SYMBOL**

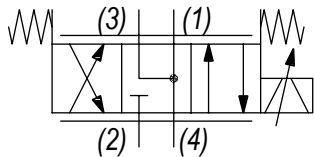

**PERFORMANCE**

**Flow vs. Current**

Coil 12 VDC - 100 Hz PWM - Oil 26 cSt (121 SSU) @ 50°C (122°F)  
Operating curves made with circuit having a pressure drop of 14bar

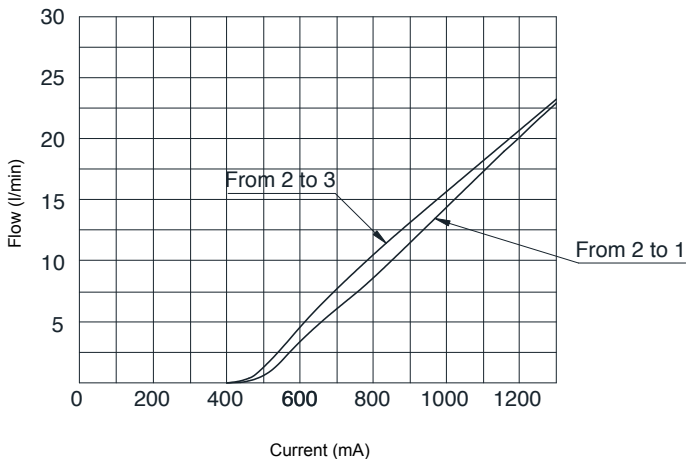

**VALVE SPECIFICATIONS**

Flow Range	See curves for various versions
Max System Pressure	3500 PSI (241 bar)
Leakage	15 cu-in/min 250 cc/min bar @ 210 bar
Hysteresis	±5%
Viscosity Range	36 to 3000 SSU (3 to 647 cSt)
Filtration	ISO 18/16/13
Media Operating Temp. Range	-30°C / +100°C
Operating Fluid Media	General Purpose Hydraulic Fluid
Cartridge Torque Requirements	25 ft-lbs (34 Nm)
Coil Nut Torque Requirements	2-3 ft-lbs (3-4 Nm)
Cavity	DELTA 4W
Cavity Tools Kit (form tool, reamer, tap)	40500002

**COIL SPECIFICATIONS**

Current Supply Characteristics	PWM (Pulse Width Modulation)
Rated Current Range	400-1400 mA
PWM or Super-Imposed	
Dither Frequency	100-200 Hz
Coil Resistance (12 VDC)	5.6 Ohm ±5% at 68°F (20°C)

**WARNING:** the specifications/application data shown in our catalogs and data sheets are intended only as a general guide for the product described (herein). Any specific application should not be undertaken without independent study, evaluation, and testing for suitability.



4484 Boeing Drive Rockford, IL 61109 • USA • Phone +1 (815) 397-6628 • Fax +1 (815) 397-2526  
mail: delta@delta-power.com • www.delta-power.com



Via Malavolti, 36 • 41122 Modena • ITALY • Phone +39 (059) 254895 • Fax +39 (059) 253152  
mail: tecnord@tecnord.com • www.tecnord.com



**DIMENSIONS**

**Pressure Drop vs. Flow**

Oil 26cSt (121 SSU) @ 50°C (122°F)

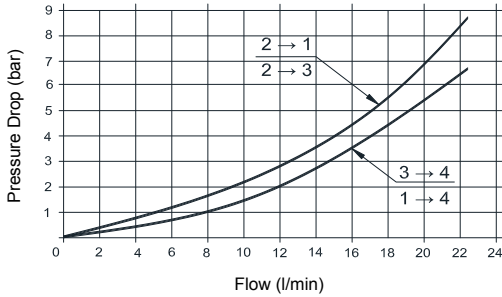

**Pressure Compensation from Inlet to Work Port**

Oil 26cSt (121 SSU) @ 50°C (122°F)

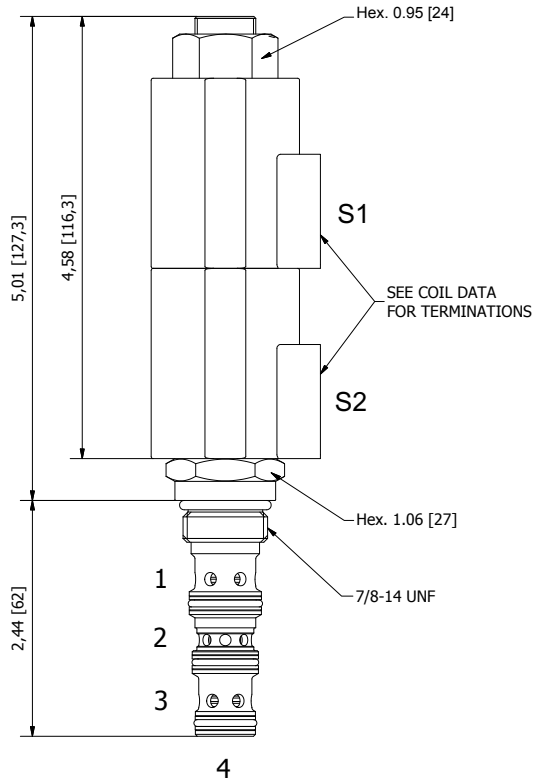
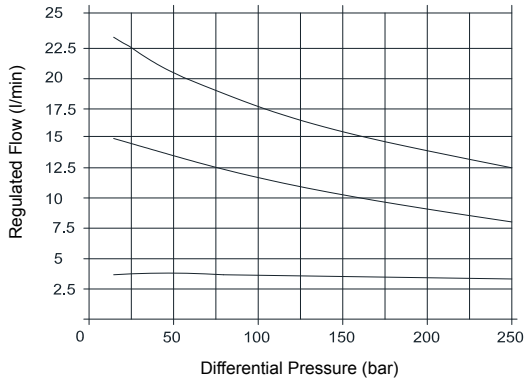

(for bodies style and sizes see section "Accessories")

**ORDERING INFORMATION**

Approximate Coil Weight: .47 lbs (.21 kg)

**EG-S4M - - - -**

**OPTIONS**  
Buna Standard **B0** Up to 22 l/min

**BODIES**  
**Blank** Without Body  
**N** 3/8" BSP Ports  
**S** #6 SAE Ports

**VOLTAGE**  
**12** 12 VDC  
**24** 24 VDC  
**22** 220 VAC

**"W" COIL TERMINATION**  
**DL** Double Lead  
**HC** DIN 43650 (Hirschmann)  
**DI** Deutsch-Integral DT04-2P

**NOTE:** for other seals, consult factory.

W/11/2018

**WARNING:** the specifications/application data shown in our catalogs and data sheets are intended only as a general guide for the product described (herein). Any specific application should not be undertaken without independent study, evaluation, and testing for suitability.



4484 Boeing Drive Rockford, IL 61109 • USA • Phone +1 (815) 397-6628 • Fax +1 (815) 397-2526  
mail: delta@delta-power.com • www.delta-power.com



Via Malavolti, 36 • 41122 Modena • ITALY • Phone +39 (059) 254895 • Fax +39 (059) 253512  
mail: tecnord@tecnord.com • www.tecnord.com

**EQ-S4P 4 WAY 3 POSITION, CYLINDER SPOOL, PROPORTIONAL DIRECTIONAL VALVE**

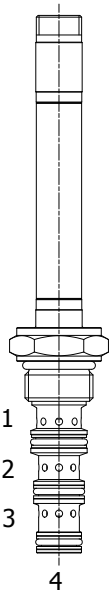

**DESCRIPTION**

8 size, 3/4-16 thread, "Power" series, solenoid operated, 4 way 3 position, Cylinder Spool, proportional directional valve.

**OPERATION**

EQ-S4P, when de-energized, blocks flow to all ports. When coil (S1) is energized, flow is allowed from (3) to (4), and from (2) to (1). When coil (S2) is energized, flow is allowed from (3) to (2), and from (4) to (1). Flow is proportional to the current applied to the coil. A compensator must be used to create a pressure compensated flow control function.

**FEATURES**

- Hardened parts for long-life.
- Industry common cavity.
- Excellent linearity and low hysteresis characteristics.
- Cartridges are voltage interchangeable.
- Optional coil voltages and terminations available.
- Unitized, molded coil design.
- Continuous duty rated solenoid.

**HYDRAULIC SYMBOL**

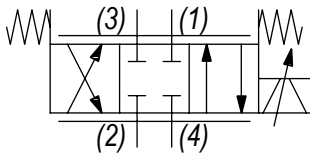

**PERFORMANCE**

**Flow vs. Current**

Coil 12VDC – 100 Hz PWM – Oil 26cSt (121 SSU) @ 50°C (122°F)  
Operating curves made with circuit having a pressure drop of 14bar

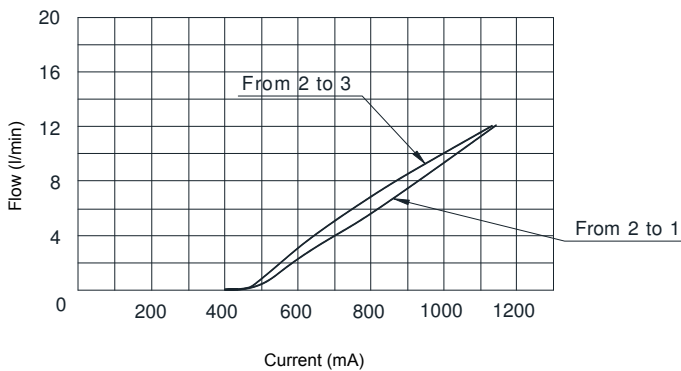

**VALVE SPECIFICATIONS**

Flow Range	See curves for various versions
Max System Pressure	3500 PSI (241 bar)
Leakage	10 cu-in/min 160 cc/min bar @ 210 bar
Hysteresis	±5%
Viscosity Range	36 to 3000 SSU (3 to 647 cSt)
Filtration	ISO 18/16/13
Media Operating Temp. Range	-30°C / +100°C
Operating Fluid Media	General Purpose Hydraulic Fluid
Cartridge Torque Requirements	18 ft-lbs (26 Nm)
Coil Nut Torque Requirements	2-3 ft-lbs (3-4 Nm)
Cavity	POWER 4W
Cavity Tools Kit (form tool, reamer, tap)	40500029

**COIL SPECIFICATIONS**

Current Supply Characteristics	PWM (Pulse Width Modulation)
Rated Current Range	400-1300 mA
PWM or Super-Imposed	
Dither Frequency	100-200 Hz
Coil Resistance (12 VDC)	6.85 Ohm ±5% at 68°F (20°C)

**WARNING:** the specifications/application data shown in our catalogs and data sheets are intended only as a general guide for the product described (herein). Any specific application should not be undertaken without independent study, evaluation, and testing for suitability.



4484 Boeing Drive Rockford, IL 61109 • USA • Phone +1 (815) 397-6628 • Fax +1 (815) 397-2526  
mail: delta@delta-power.com • www.delta-power.com



Via Malavolti, 36 • 41122 Modena • ITALY • Phone +39 (059) 254895 • Fax +39 (059) 253512  
mail: tecnord@tecnord.com • www.tecnord.com

**DIMENSIONS**

**Pressure Drop vs. Flow**  
Oil 26cSt (121 SSU)@ 50°C (122°F)

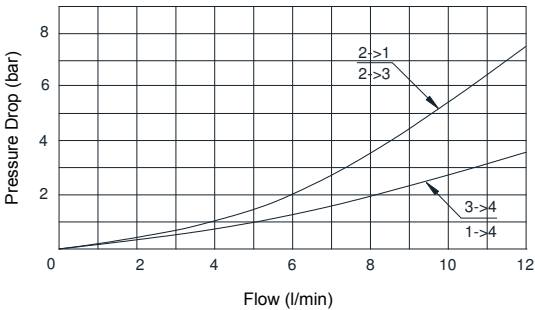

**Pressure Compensation from Inlet to Work Port**  
Oil 26cSt (121 SSU)@ 50°C (122°F)

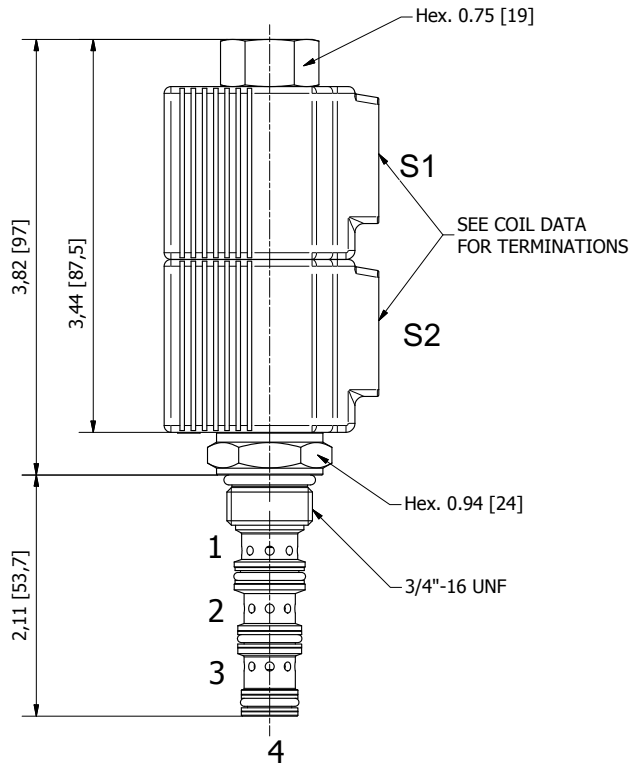
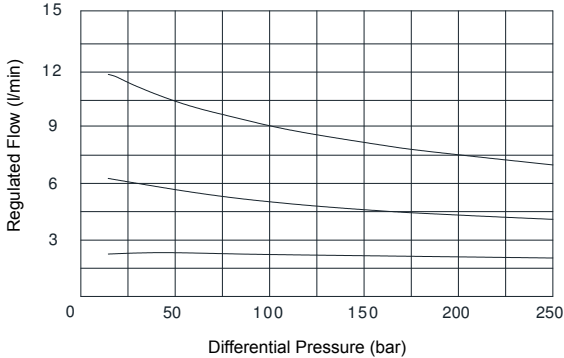

(for bodies style and sizes see section "Accessories")

**ORDERING INFORMATION**

Approximate Coil Weight: .47 lbs (.21 kg)

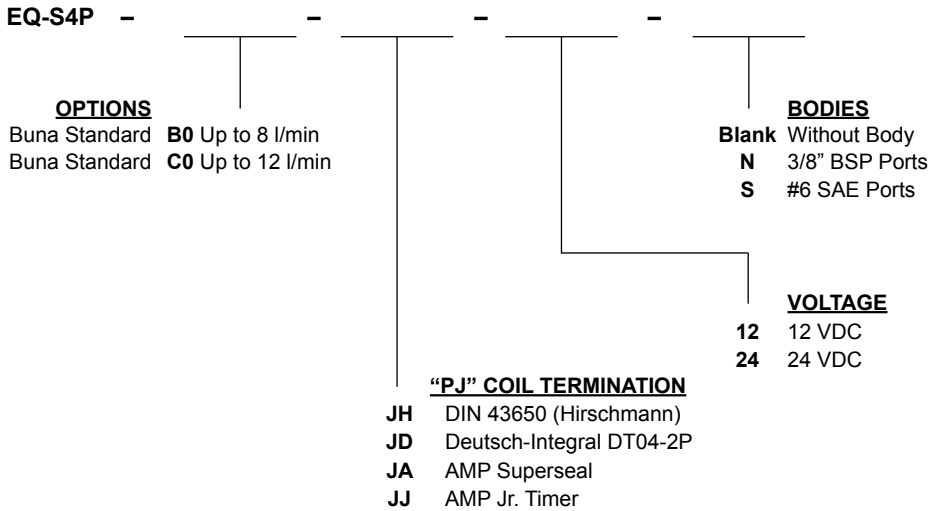

**NOTE:** for other seals, consult factory.

W/11 /2018

**WARNING:** the specifications/application data shown in our catalogs and data sheets are intended only as a general guide for the product described (herein). Any specific application should not be undertaken without independent study, evaluation, and testing for suitability.



4484 Boeing Drive Rockford, IL 61109 • USA • Phone +1 (815) 397-6628 • Fax +1 (815) 397-2526  
mail: delta@delta-power.com • www.delta-power.com



Via Malavolti, 36 • 41122 Modena • ITALY • Phone +39 (059) 254895 • Fax +39 (059) 253512  
mail: tecnord@tecnord.com • www.tecnord.com

**EG-S4P 4 WAY 3 POSITION, CYLINDER SPOOL, PROPORTIONAL DIRECTIONAL VALVE**

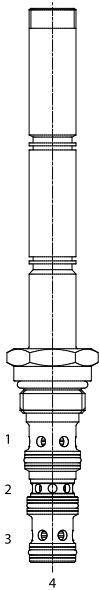

**DESCRIPTION**

10 size, 7/8-14 thread, "Delta" series, solenoid operated, 4 way 3 position, Cylinder Spool, proportional directional valve.

**OPERATION**

EG-S4P, when de-energized, blocks flow to all ports. When coil (S1) is energized, flow is allowed from (3) to (4), and from (2) to (1). When coil (S2) is energized, flow is allowed from (3) to (2), and from (4) to (1). Flow is proportional to the current applied to the coil. A compensator must be used to create a pressure compensated flow control function.

**FEATURES**

- Hardened parts for long-life.
- Industry common cavity.
- Excellent linearity and low hysteresis characteristics.
- Cartridges are voltage interchangeable.
- Optional coil voltages and terminations available.
- Unitized, molded coil design.
- Continuous duty rated solenoid.

**HYDRAULIC SYMBOL**

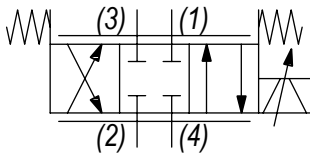

**PERFORMANCE**

**Flow vs. Current**

Coil 12 VDC - 100 Hz PWM - Oil 26 cSt (121 SSU) @ 50°C (122°F)  
Operating curves made with circuit having a pressure drop of 14bar

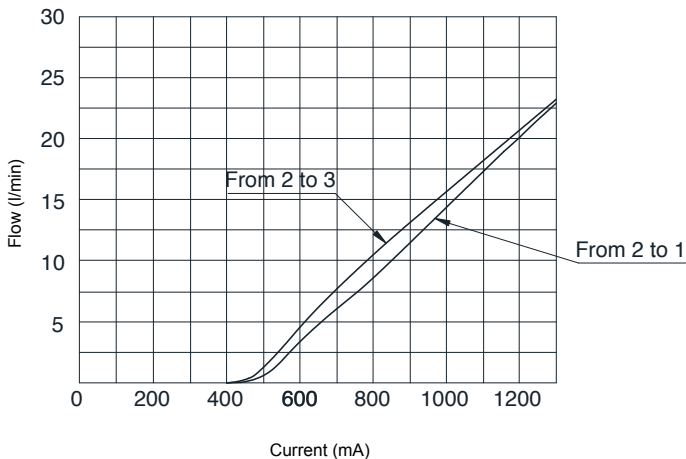

**VALVE SPECIFICATIONS**

Flow Range	See curves for various versions
Max System Pressure	3500 PSI (241 bar)
Leakage	15 cu-in/min 250 cc/min bar @ 210 bar
Hysteresis	±5%
Viscosity Range	36 to 3000 SSU (3 to 647 cSt)
Filtration	ISO 18/16/13
Media Operating Temp. Range	-30°C / +100°C
Operating Fluid Media	General Purpose Hydraulic Fluid
Cartridge Torque Requirements	25 ft-lbs (34 Nm)
Coil Nut Torque Requirements	2-3 ft-lbs (3-4 Nm)
Cavity	DELTA 4W
Cavity Tools Kit (form tool, reamer, tap)	40500002

**COIL SPECIFICATIONS**

Current Supply Characteristics	PWM (Pulse Width Modulation)
Rated Current Range	400-1400 mA
PWM or Super-Imposed	
Dither Frequency	100-200 Hz
Coil Resistance (12 VDC)	5.6 Ohm ±5% at 68°F (20°C)

**WARNING:** the specifications/application data shown in our catalogs and data sheets are intended only as a general guide for the product described (herein). Any specific application should not be undertaken without independent study, evaluation, and testing for suitability.



4484 Boeing Drive Rockford, IL 61109 • USA • Phone +1 (815) 397-6628 • Fax +1 (815) 397-2526  
mail: delta@delta-power.com • www.delta-power.com



Via Malavolti, 36 • 41122 Modena • ITALY • Phone +39 (059) 254895 • Fax +39 (059) 253512  
mail: tecnord@tecnord.com • www.tecnord.com

**DIMENSIONS**

**Pressure Drop vs. Flow**

Oil 26cSt (121 SSU) @ 50°C (122°F)

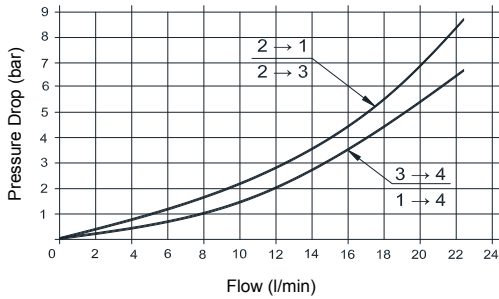

**Pressure Compensation from Inlet to Work Port**

Oil 26cSt (121 SSU) @ 50°C (122°F)

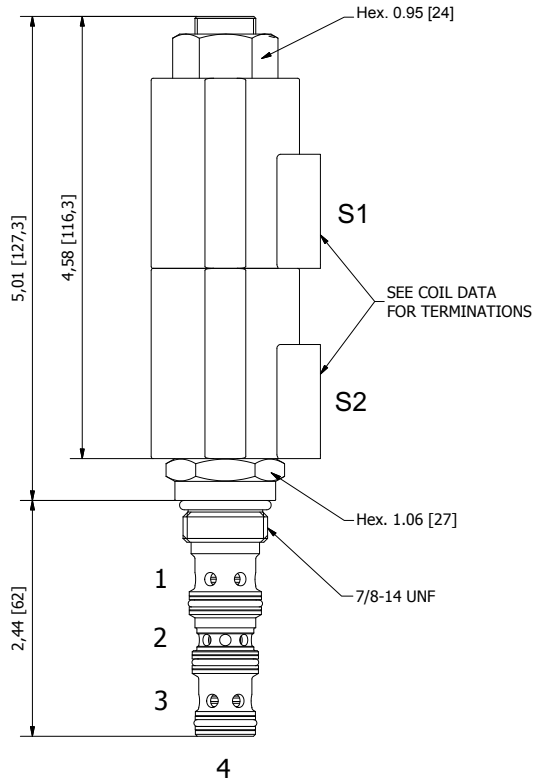
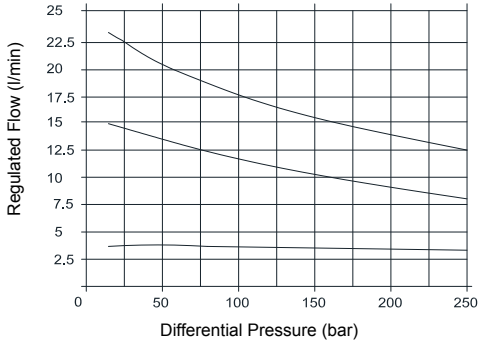

(for bodies style and sizes see section "Accessories")

**ORDERING INFORMATION**

Approximate Coil Weight: .47 lbs (.21 kg)

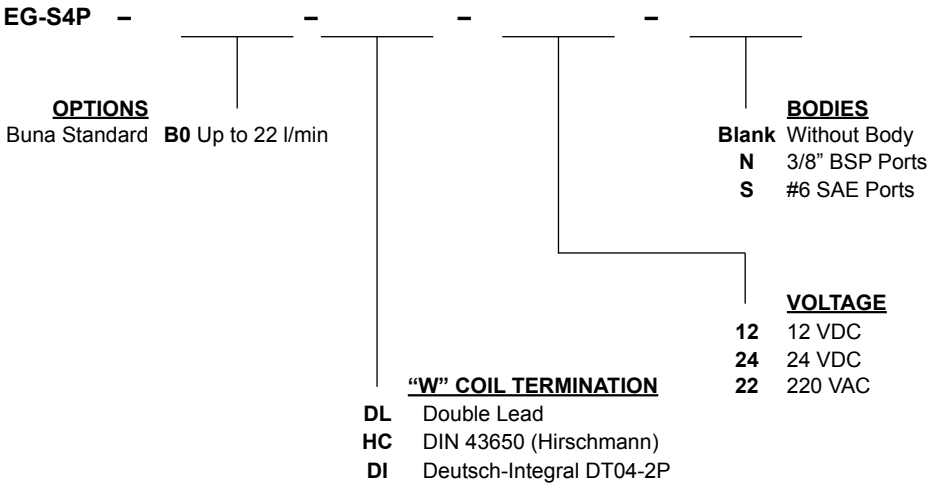

**NOTE:** for other seals, consult factory.

W/11/2018 **WARNING:** the specifications/application data shown in our catalogs and data sheets are intended only as a general guide for the product described (herein). Any specific application should not be undertaken without independent study, evaluation, and testing for suitability.



4484 Boeing Drive Rockford, IL 61109 • USA • Phone +1 (815) 397-6628 • Fax +1 (815) 397-2526  
 mail: delta@delta-power.com • www.delta-power.com



Via Malavolti, 36 • 41122 Modena • ITALY • Phone +39 (059) 254895 • Fax +39 (059) 253512  
 mail: tecnord@tecnord.com • www.tecnord.com

**WARNING:** *the specifications/application data shown in our catalogs and data sheets are intended only as a general guide for the product described (herein). Any specific application should not be undertaken without independent study, evaluation, and testing for suitability.*



4484 Boeing Drive Rockford, IL 61109 • USA • Phone +1 (815) 397-6628 • Fax +1 (815) 397-2526  
mail: [delta@delta-power.com](mailto:delta@delta-power.com) • [www.delta-power.com](http://www.delta-power.com)



Via Malavolti, 36 • 41122 Modena • ITALY • Phone +39 (059) 254895 • Fax +39 (059) 253512  
mail: [tecnord@tecnord.com](mailto:tecnord@tecnord.com) • [www.tecnord.com](http://www.tecnord.com)